



S2 MPC



Sen2Cor Configuration and User Manual

*Ref. S2-PDGS-MPC-L2A-SUM-V2.10
Issue 1*



This Page is intentionally Blank

Authors Table

	Name	Company	Responsibility	Date	Signature
Written by	F.C. Pignatale	TPZG	Sen2Cor Maintenance	2021-12-13	
Verified by	O Devignot	CS	Quality Manager	2021-12-13	
Approved by	L. Pessiot	CS	Service Manager	2021-12-13	

Change Log

Issue	Date	Reason for change	Pages(s)/Section(s)
1.0	2.July 2012	Created	All
1.1	15 September 2012	Issue after S2PAD Phase 2 CDR. Updated according to ESA comments and discussion on CDR 02/08/2012	All
1.2	1.June 2013	Adaptation of installation procedures according to unification of environments and pre-release of processor for QR	2.4
1.3	31. March 2014	New Section 2.2, updated Installation procedures for Windows, moved information for data IO into new created document [S2-PDGS-MPC-L2A-IODD]	2.2
1.4	27. June 2014	Restructuring of sections 3.1, 3.2 to align the installation after upgrades of Anaconda and GDAL.	3.1.3
2.0	15.May 2015	Integration into Sentinel-2 Toolbox, Version 2.0 Complete Improvement of Installation Procedure: Integration of CONDA Packages for GDAL and GLYMUR Upgrade to PSD V12 Upgrade of JPEG-2000 Readers to OpenJPEG 2.1.0 instead of Jasper Fixes of SPRs according to Release note for Version 2.0	3.1
2.1	10.02.2016	Parallelisation on tile base implemented Upgrade to PSD V13.1	2.5
2.2	13.04.2016	Integration of Look-Up-Tables Automated Aerosol determination Automated Ozone selection New description for DEM selection Various improvements for command line Handling	2.2.2, 2.2.7, 3.3.3

Issue	Date	Reason for change	Pages(s)/Section(s)
2.3	25.11.2016	Corrected command line options according to SIIMPC-686 Updated installation procedure in section 3.1 Added new configuration items in section 3.3.3. Added offset for DEM output	2.2.7, 3.1, 3.3.3
2.4	30.06.2017	Removed old installation procedure, now referring to release note Added copyright notes	3.1,5
2.5	15.11.2017	New section for Sen2Cor 2.5.0 configuration updates	3.2.1
2.6	08.02.2018	New section for Sen2Cor 2.6.0 operation mode	3.3.1
2.6.1	26.02.2018	Updated command line description and removed constraints for Toolbox mode	3.3.1
		Removed section on old PDGS interface as was implemented for Sen2Cor 2.1 due to new Tile mode	N/A
		Added insertions and comments from J. Louis after internal document review	All sections
2.6.2 – 2.6.6	24.07.2018	Improved description on automated aerosol type determination.	2.2.2.2.2
		Updated description of the processing routines for band resampling.	2.4.2 – 2.4.6
		Removed section on parallelisation of tile processing, due to single tile inputs. Changed information on memory requirements due to optimisation.	2.5
		Inserted information for standard SAFE or SAFE compact.	3.3, 3.3.1, 3.3.2
		Added / changed information for raw data selection and resolution	3.3.1, 3.3.2
2.7.0	21.09.2018	Added new command line parameters for database locations	2.4.1
		New parameter for Database Compression factor	2.4.1
		Split image database into two entities and optimized disk usage	2.4.1
		New parameter for Disabling Terrain Correction with DEM	2.4.1
2.7.1	11.10.2018	Adding hints for location of databases	2.4.1
2.7.2	14.12.2018	Adding the two new command line parameters for processing_centre and processing_baseline Removed the unused parameter refresh	3.3.2

Issue	Date	Reason for change	Pages(s)/Section(s)
2.8.0	16.01.2019	Added description for multithreading with OpenJPEG and removed description for multi-tile processing. Updated version numbers for reference documents.	2.4.1 2.5.1
2.9.0	19.06.2020	Added feature for process termination if DEM error occurs.	2.2.7
		Added description for automatic and manual mode of Region of Interest.	2.4.2
		Updated section of Software Development Environment.	3.4
2.10.0	13.12.2021	Updated sections and descriptions with the implementations present in Sen2Cor 2.10.0	Various sections

Table of contents

1. INTRODUCTION	8
1.1 Purpose of the document	8
1.2 Document Structure	8
1.3 References	9
2. FUNCTIONALITY AND OPERATION	10
2.1 Level-2A Processor Architecture	10
2.2 Workflow	13
2.2.1 Scene Classification (L2A_SceneClass)	13
2.2.2 Scene Classification Evolution (L2A_SceneClass_evolution)	15
2.2.3 Atmospheric Correction (L2A_AtmCorr)	15
2.2.4 Aerosol Optical Thickness	18
2.2.5 Water Vapour Retrieval	20
2.2.6 Cirrus Correction	21
2.2.7 Surface Reflectance Retrieval	21
2.2.8 Usage of Digital Elevation Maps	22
2.2.9 Quality Mask	24
2.3 Product Formatting	25
2.4 Runtime Configuration	26
2.4.1 Pre-processing (L2A_Tables)	26
2.4.2 Improvement of the Processing Routines	29
2.4.3 The 60 m Product Processing	30
2.4.4 The 20 m Product Processing	31
2.4.5 The 10 m Product Processing	31
2.4.6 Post-Processing	31
2.4.7 Configuration recommendations	32
2.5 Memory Requirements	34
2.6 Interface changes:	34
2.6.1 Other Changes:	35
2.7 Logging (Logger)	35
3. CONFIGURATION AND INSTALLATION	37
3.1 Installation and Setup	37
3.1.1 ESACCI-LC package for SC module	37
3.2 Configuration Files	38
3.2.1 L2A_GIPP.xml	38
3.3 Operation	39
3.3.1 Command Line Options since Sen2Cor Version 2.7.0	39
3.3.2 Command line Options for TOOLBOX mode	42
3.3.3 Integration into the Sentinel-2 Toolbox	43
3.4 The Software Development Environment	44

3.4.1	Set up of the python runtime environment:.....	44
3.4.2	The PyCharm IDE	45
3.4.3	Configuration	45
3.4.4	Conda environment yml.....	45
4.	REFERENCES	47
5.	COPYRIGHT NOTES	48

List of Figures

Figure 2-1	– Sentinel-2 Spectral Bands and Resolutions	10
Figure 2-2	– High Level Processor Architecture	12
Figure 2-3	– Scene Classification Module	12
Figure 2-4	– Atmospheric Correction Module	12
Figure 2-5	– Processing Flow, Overview	13
Figure 2-6	– Scene Classification	14
Figure 2-7	– Scene Classification, Processing Flow	15
Figure 2-8	– Atmospheric Correction, Processing Flow	16
Figure 2-9	– AOT Retrieval using Band 12.....	19
Figure 2-10	– WV Retrieval using Bands 8a and 9.....	20
Figure 2-11	– Cirrus Correction over north Denmark, Bands 2-4 with Band 10. Left: L2A Output cirrus corrected, right: without correction.	21
Figure 2-12	– Left: Level 1C Input, Bands 2-4; right: Level 2A Output, Bands 2-4, RGB composite images, scene from La Paz on	22
Figure 2-13	– Terrain correction; Left: Level 1C Input, Bands 2-4, RGB composite image, middle: DEM, reshaped to according scene, right: Level 2A Output, Bands 2-4, RGB composite image.....	24
Figure 2-14	– L2A TCI image of a tile processed with a Quality Mask masking defective pixels of different affected bands.	25
Figure 2-15	– Filing structure of Level-1C product on tile level	26
Figure 2-16	– Performance improvement using OpenJPEG 2.3 and multithreading.....	27
Figure 2-17	– Manual configuration of a 3000 x 3000 frame window. Absolute processing time in minutes and percentages between full processing and sub-tile.....	30
Figure 2-18	– Tests on Autodetection. Absolute processing time in minutes and percentages between full processing and auto mode	30
Figure 2-19	– Level 2A product, physical format Configuration (L2A_Config).....	32
Figure 2-20	– Memory Consumption during processing.....	34
Figure 3-21	– Registration of Sen2Cor Conda Environment in PyCharm	45
Figure 3-22	– Connection of Sen2Cor Sources with Run Time Environment..	46

List of Tables

Table 2-1	– Classification Map	14
Table 2-2	– Parameter space for atmospheric correction.....	16
Table 2-3	– CAMS auxiliary input	19

1. Introduction

1.1 Purpose of the document

This document is the Software *Installation and User Manual (SUM)* for the Sentinel-2 Level-2A Prototype Processor, which is labelled **Sen2Cor** for **Sentinel 2** (atmospheric) **Correction**.

The prototype implementation for the Level 2A processing of Sentinel-2 imagery over land is a combination of state-of-the-art techniques for performing Atmospheric Corrections (AC, including Cirrus clouds and terrain correction), tailored to the Sentinel-2 environment and a Scene Classification (SC) with two available modules since the version 2.10.

Sen2Cor performs a pre-processing of Level-1C (L1C) Top of Atmosphere (TOA) image data, and applies a scene classification, an atmospheric correction and a subsequent conversion into an ortho-image Level-2A Bottom-Of-Atmosphere (BOA) reflectance product. Outputs are an Aerosol Optical Thickness (AOT) map, a Water Vapour (WV) map and a Scene Classification map together with Quality Indicators data. Details of the products and its contents is provided in [L2A-PDD] of section 1.3.

Level-2A (L2A) products are re-sampled as L1C products with a constant GSD (Ground Sampling Distance) of 10m, 20m and 60 m according to the native resolution of the different spectral bands. If applicable, Level-2A products are provided for each MSI channel at coarser resolution (i.e. 20 m and 60 m) as well.

A large database of look-up tables (LUTs) has been compiled using an atmospheric radiative transfer model based on LibRadtran¹. The LUTs are generated for a wide variety of atmospheric conditions, solar geometries, ground elevations and are calculated with a high spectral resolution of 0.6 nm. This database has been subsequently resampled with the Sentinel-2 spectral responses, in order to obtain the sensor-specific functions needed for the atmospheric correction.

1.2 Document Structure

The configuration and user manual consists of the following chapters and sections:

Chapter, Section	Description
1	this chapter
2	Introduces the Sen2Cor system. What is the general purpose of the application, how it is structured, what are the processing schemes. It lists the general system architecture modules and functionality and gives a brief overview on its functionality and operation.
3	Introduces the two different environments (runtime and development) of the system in general and the source code distribution.

¹ <https://www.libradtran.org>

3.1	How to install the processor software and the according runtime environment.
3.2	How to configure the processor software and the according runtime environment.
3.3	How to run the processor software in the according runtime environment.
3.4	Describes the setup configuration and operation of the software development environment, set up on top of Eclipse and PyDev. Contains also a detailed overview on all used third party tools.

With these sections the configuration and user manual enables developers to upgrade and maintain the software and users of the software to operate the system within their specific hardware environment.

What this document will not provide is the scientific background of the application. This is part of the corresponding ATBD [S2-PDGS-MPC-L2A-ATBD]. In addition, the configuration of the processor has been moved into [S2-PDGS-MPC-L2A-IODD]. In order to avoid redundancies and inconsistencies between the different project documents, this content will thus not be repeated here. If it is necessary for the understanding of the operation, this SUM will refer to the according chapters of [S2-PDGS-MPC-L2A-IODD], [S2-PDD].

1.3 References

Document ID	Description	Version
S2-PDGS-MPC-L2A-PFS	Sentinel-2 MSI – Product Format Specification	14.6,14.9
S2-PDGS-MPC-L2A-IODD	Sentinel-2 MSI – Level 2A Prototype Processor Input Output Definition Document	2.10
S2-PDGS-MPC-L2A-ATBD	Sentinel-2 MSI - Level 2A Products, Algorithm Theoretical Basis Document	2.10
S2-PDD	GMES Space Component – Sentinel-2 Payload Data Ground Segment (PDGS), Product Definition Document	14.9_4.9
S2-PSD	Sentinel-2 Products Specification Document	14.6,14.9

2. Functionality and Operation

Sen2Cor is a prototype processor for Sentinel-2 Level 2A product formatting and processing. The processor performs the tasks of atmospheric-, terrain and cirrus correction and a SC of Level 1C input data. Level 2A outputs are: Bottom-Of-Atmosphere (BOA), optionally terrain- and cirrus corrected reflectance images, AOT-, WV-, SC maps and Quality Indicators, including cloud and snow probabilities. The Level 2A Product Formatting performed by the processor follows the specification of the Level 1C User Product. Details are given in [S2-PDGS-MPC-L2A-PFS].

The Sentinel-2 Multi-Spectral Instrument (MSI) consists of 13 spectral bands with three different resolutions (10m, 20m and 60m) as shown in Figure 2-1. The instrument covers a 290 km swath. The Level-1C image product, which serves as the input for the Level-2A processing consists of a series of n tiles, each with a 100 km square. Each tile consists of thirteen compressed JPEG-2000 images, each image representing one single band. The thirteen bands have three different resolutions (10m, 20m and 60m) which lead to different image dimensions of the Level-1C input product. These details are given in [L2A-PDD] and [L2A-IODD].

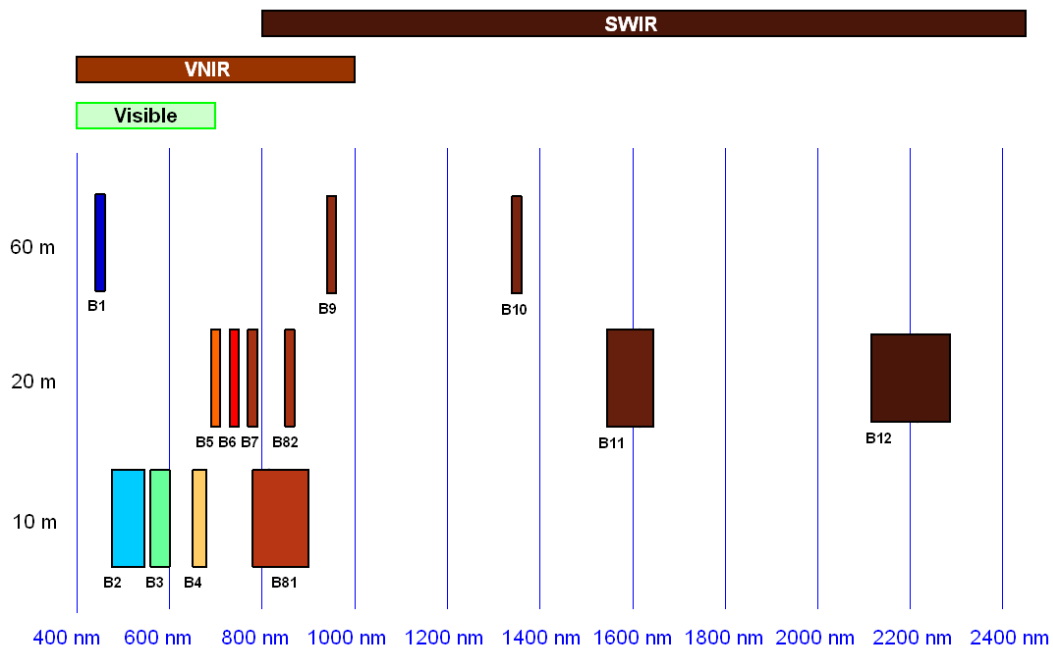

Figure 2-1 – Sentinel-2 Spectral Bands and Resolutions

2.1 Level-2A Processor Architecture

It follows a high level description of the processor architecture:

The Sen2Cor application is designed by the following essential modules (classes):

1. **L2A_Process**: the general operator module, which coordinates the interaction between the other modules and creates the skeleton L2A product structure of the metadata (see Figure 2-2).

2. **L2A_ProcessTileToolbox:** a single processing module, executing the tasks of scene classification, atmospheric correction and the creation of metadata on tile base.
3. **L2A_SceneClass (SC):** performs the coarse classification of the input images into their different contents like clouds, snow, water, soil etc. and provides statistical analysis (see Figure 2-3). Replaced in Sen2Cor 2.10 by the new L2A_SceneClass_Evolution, the classic version as for version 2.9 is still available with a dedicated command line (--sc_classic).
4. **L2A_SceneClass_Evolution(SC):** includes an update of several algorithms in order to handle the improvement of the topographic/casted shadow, reduce false snow detection, inclusion of cloud/shadow dilation, usage of S2 MSI parallax properties to mitigate false cloud and false snow detection, and replacement of ESA CCI Snow condition with an ESA CCI derived snow monthly climatology. It is the default Scene Classification module in Sen2Cor 2.10.
5. **L2A_AtmCorr (AC):** transforms the input from top of atmosphere (TOA) to bottom of atmosphere (BOA) representation and performs the atmospheric correction of the input (see Figure 2-4).
6. **L2A_Config:** a helper class providing the configuration parameters to all other modules listed above.
7. **L2A_Tables:** a helper class, managing the conversion of the JPEG-2000 based input data to an internal format (and vice versa) and providing a high performance access to the data for the processing modules (see section 2.4.1). It uses its own private L2A_Config instance.
8. **L2A_Manifest:** a class specialized for the generation of the manifest on product level.
9. **L2A_XmlParser:** a utility class for parsing the metadata and GIPP files on demand.
10. **L2A_Library:** a collection of common tools used by all classes on demand.
11. **L2A_Quality:** a class specialized for the generation of the new Quality report. New in Sen2Cor 2.10.

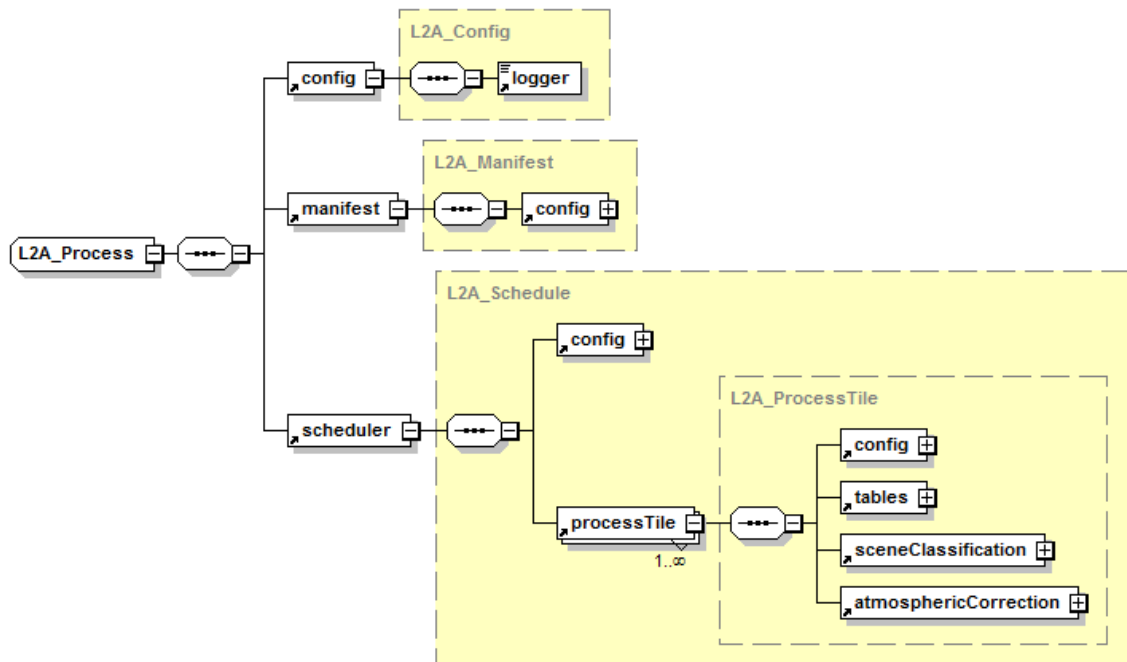

Generated by XMLSpy

www.altova.com

Figure 2-2 – High Level Processor Architecture

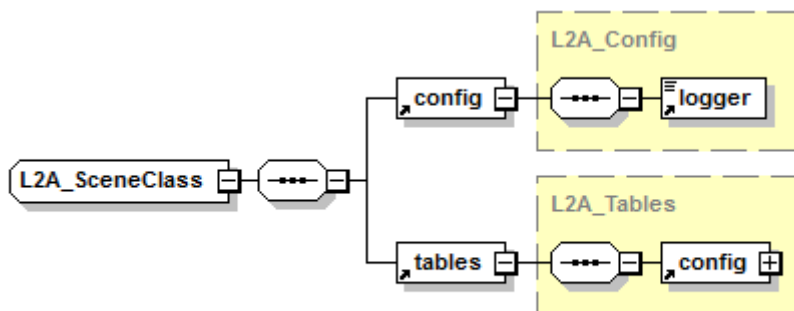

Generated by XMLSpy

www.altova.com

Figure 2-3 – Scene Classification Module

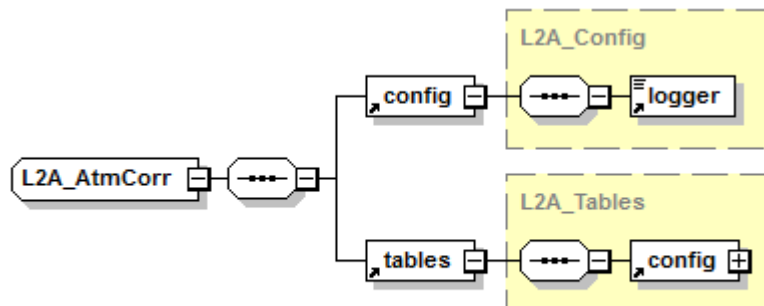

Generated by XMLSpy

www.altova.com

Figure 2-4 – Atmospheric Correction Module

2.2 Workflow

Figure 2-5 below shows the main processing workflow. After reading and processing the input parameter and data, the main processing module triggers the creation of an internal temporary database, which is then used by the SC and the AC module to retrieve and to store the data and intermediate products. The processing can act in a loop, depending on the number of different product resolutions that have to be generated.

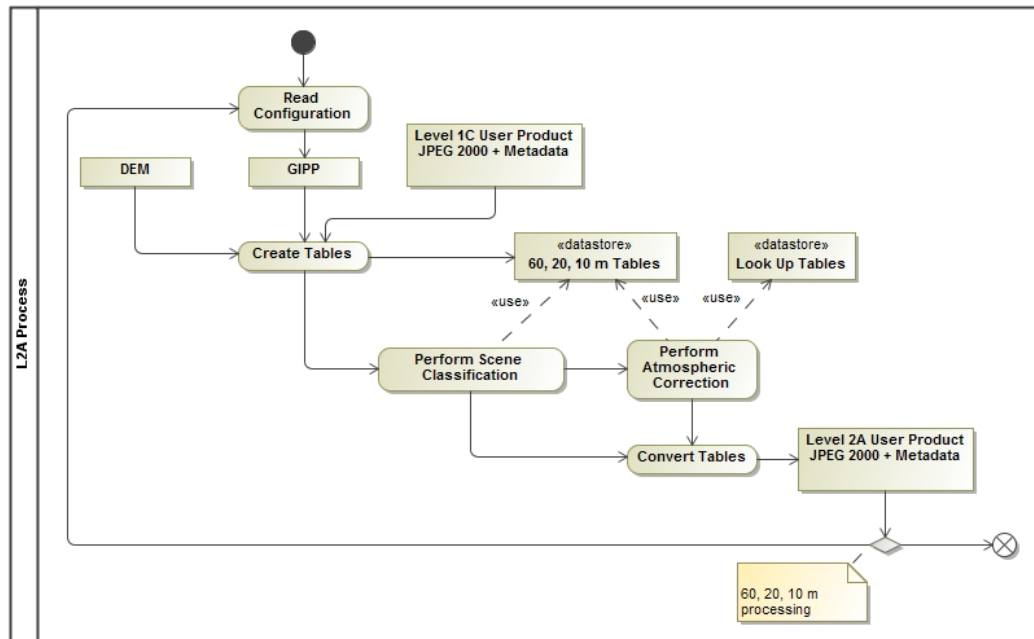

Figure 2-5 – Processing Flow, Overview

2.2.1 Scene Classification (L2A_SceneClass)

The SC algorithm allows to detect clouds, snow and cloud shadows and to generate a classification map, which consists of 3 different classes for clouds (including cirrus), together with six different classifications for shadows, cloud shadows, vegetation, soils / deserts, water and snow. The algorithm is based on a series of threshold tests that use as input top-of-atmosphere reflectance from the Sentinel-2 spectral bands. In addition, thresholds are applied on band ratios and indexes like the Normalized Difference Vegetation - and Snow Index (NDVI, NDSI [3]). For each of these thresholds tests, a level of confidence is associated. At the end of the processing chain a probabilistic cloud mask quality map and a snow mask quality map is produced. The algorithm uses the reflective properties of scene features to establish the presence or absence of clouds in a scene. Cloud screening is applied to the data in order to retrieve accurate atmospheric and surface parameters, either as input for the further processing steps below or for being valuable input for processing steps of higher levels. Figure 2-6 below shows the results of a SC (right side) based on modified AVIRIS test data (left side). Twelve different classifications are provided, see Table 2-1.

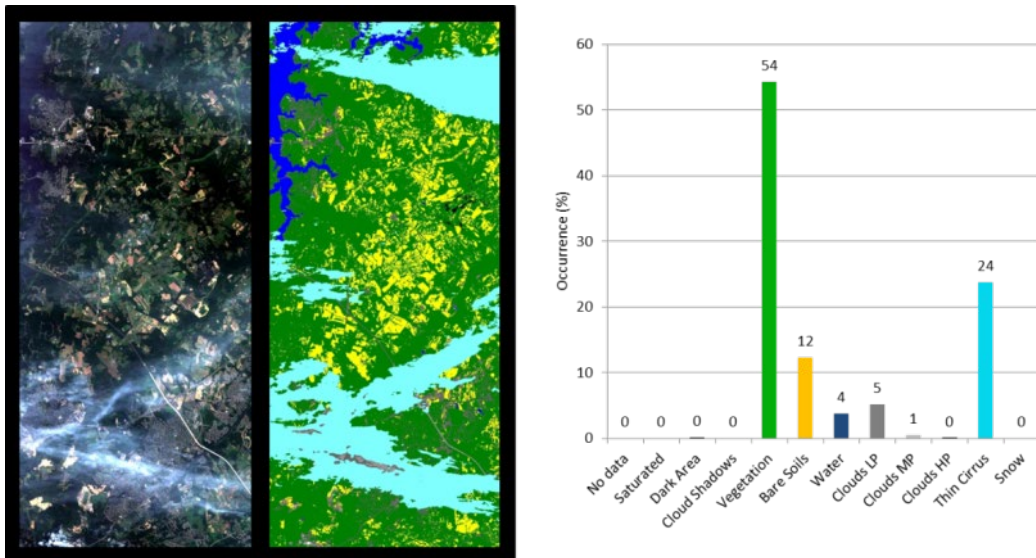

Figure 2-6 – Scene Classification

Table 2-1 – Classification Map

Label	Classification
0	NO_DATA
1	SATURATED_OR_DEFECTIVE
2	CASTED_SHADOWS
3	CLOUD_SHADOWS
4	VEGETATION
5	NOT_VEGETATED
6	WATER
7	UNCLASSIFIED
8	CLOUD_MEDIUM_PROBABILITY
9	CLOUD_HIGH_PROBABILITY
10	THIN_CIRRUS
11	SNOW

Associated quality indicators on snow and cloud probability are generated from the results. These Quality indicators calculate the probability (0-100%) that the earth surface is obstructed by clouds or optically thick aerosol (ice or snow).

The SC processing consists of five different steps:

1. Snow detection;
2. Cloud detection;
3. Cirrus detection;
4. Cloud shadow detection;
5. Classification map generation.

The processing is shown in the flow diagram in Figure 2-7.

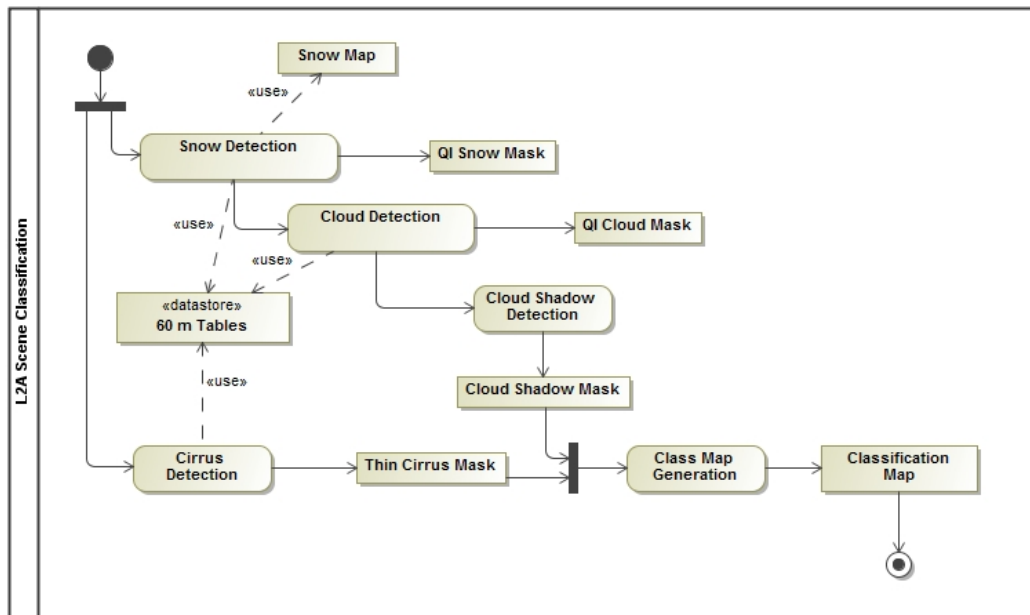

Figure 2-7 – Scene Classification, Processing Flow

Details of this algorithm, especially on the different threshold conditions are given in chapter 3 of [S2-PDGS-MPC-L2A-ATBD].

2.2.2 Scene Classification Evolution (L2A_SceneClass_evolution)

This new version improves the accuracy of the scene classification map. Updates includes several algorithms in order to handle the improvement of the topographic/casted shadow, inclusion of cloud/shadow dilation, usage of S2 MSI parallax properties to mitigate false cloud and false snow detection and replacement of ESA CCI snow condition with an ESA CCI derived from snow monthly climatology. This is the new default for Sen2Cor. It is still possible to select the classic version of the scene classification by using the command line '--sc classic'.

2.2.3 Atmospheric Correction (L2A_AtmCorr)

The AC processing consists of a set of different subtasks, (AOT, WV and surface reflectance retrieval, optional with terrain and cirrus correction), having three different user products as output: AOT and WV tables on pixel level and the BOA corrected reflectance images for all bands measured. Figure 2-8 below shows the processing flow for the atmospheric correction module.

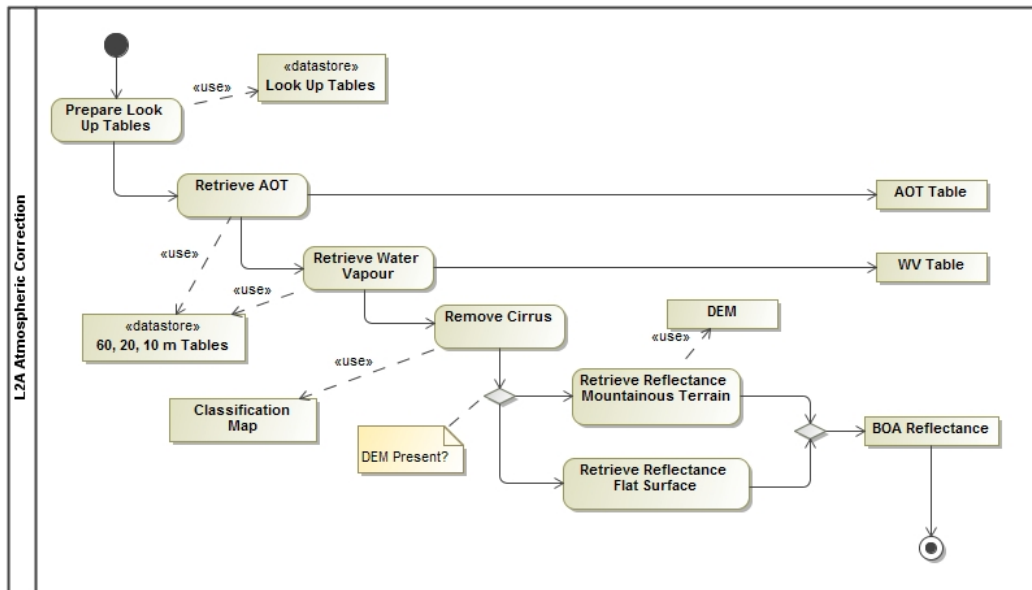

Figure 2-8 – Atmospheric Correction, Processing Flow

2.2.3.1 Look-Up-Tables Generation

The atmospheric model of Sen2Cor (L2A_AtMCorr) is dependent on the calculation of radiative transfer functions for different sensor and solar geometries, ground elevations, and atmospheric parameters. The list in Table 2-2, presents a 6 dimensional parameter space and the grid spacing for each parameter. The processor reads the parameter in form of Look-Up-Tables (LUTs) pertaining to this parameter space and interpolates, if required. The LUTs have been generated via LibRadtran, a library for the calculation of solar and thermal radiation in the Earth's atmosphere.

Table 2-2 – Parameter space for atmospheric correction

Parameter	Range	Increment / grid points
Solar zenith angle	0 -70°	10°
Sensor view angle	0 -10°	10°
Relative azimuth angle	0 -180°	30°(180°= backscatter)
Ground elevation	0 -2.5 km	0.5 km
Visibility	5 -120 km	5, 7, 10, 15, 23, 40, 80, 120 km
Water vapour, summer	0.4 -5.5 cm	0.4, 1.0, 2.0, 2.9, 4.0, 5.0 cm
Water vapour, winter	0.2 -1.5 cm	0.2, 0.4, 0.8, 1.1 cm

Starting with Sen2Cor release 2.2.0 the user can select between four atmospheric models: a set of 24 LUTs has been integrated to cover most of atmospheric conditions on Earth for the Sentinel-2 mission. In the Sen2Cor context, a set of LUTs is composed by 6 or 4 LUTs files depending on the total water vapour columns content of the atmosphere. Different LUTs are calculated for the mid-latitude

summer and mid-latitude winter atmospheres, with 6 different (sea level) ozone contents, a rural and a maritime aerosol, 6 or 4 different sea level water vapour columns. For each supported water vapour level, the ground-to-space water vapour column depending on elevation according to the atmosphere temperature / humidity vertical profile is provided.

Sen2Cor LUTs are calculated for:

- 2 different types of aerosols (rural and maritime)
- 2 different types of atmospheres (mid latitude summer and mid latitude winter)
- 6 different types of ozone concentrations (depending on summer or winter case)
- 6 or 4 different amounts of water vapour column (depending on summer or winter)

2.2.3.2 User configuration

The LUTs selection is configurable via the user configuration file (L2A_GIPP.xml) located inside the cfg folder of the directory where the \$SEN2COR_HOME environment variable points to. In the Look_Up_Tables selection of the configuration file, three entries: Aerosol_Type, Mid_Latitude and Ozone_Content can be set. The water vapour columns are set internally.

Default processing via configuration is the rural (continental) aerosol type with mid latitude summer and an ozone concentration of 331 Dobson Units.

Please refer to [S2-PDGS-MPC-L2A-IODD] for details.

2.2.3.2.1 Setting of Automated Ozone Input

Ozone content may be specified by indicating a value in Dobson Units in the configuration file or it can be extracted from the auxiliary data in the L1C product by setting ozone content to '0' in the configuration file. In both cases the LUTs with the smallest difference between the specified value and the discrete set of LUTs ozone grid points are selected.

2.2.3.2.2 Setting Aerosol type (RURAL, MARITIME, AUTO)

The aerosol type can be set to rural or maritime aerosols or auto-selected by the algorithm between these two. If the user sets the Aerosol_Type to 'AUTO', the processor will determine it automatically. In that case, the processor will process two (aerosol only) test trials before the final processing of the atmospheric correction takes place.

The scene path radiance in the blue and red region is calculated as the total, minus the reflected radiance, using the average values obtained for the dark reference pixels. After calculation of the scene path radiance, the ratio of the path radiance for the blue channel scene compared to the red channel scene is compared to the corresponding ratio of the existing aerosols (RURAL, MARITIME) from the look up tables.

The aerosol type for which the double ratio (dp) is closest to 1 is the best approximation for the scene and will be selected and used in all subsequent measures for the corresponding tile.

As the derived aerosol type is constant per scene in the Sen2Cor model, the question arises whether the automatic selection is the best choice, especially if one

considers neighbouring scenes. In this case, the aerosol types could switch, leading to steps in the surface reflectance at the image borders. From this point of view a pre-selected aerosol type (e.g. rural-continental) might be the better choice in practice (see S2-PDGS-MPC-L2A-ATBD).

2.2.3.2.3 Setting Atmosphere (AUTO, SUMMER, WINTER)

In the same way as for the aerosol type, the atmospheric profiles can be fixed to summer and winter profiles or auto-selected by the algorithm. If set to 'AUTO' the processor will select WINTER or SUMMER atmosphere profile based on the acquisition date and geographic location of the tile.

2.2.3.2.4 Setting Blue path radiance rescaling

Blue path radiance rescaling is some fine-tuning of path radiance for bands B01 to B03 to adjust the limited set of standard aerosol types available in the LUTs to the actual spectral behaviour of the path radiance in the blue spectral region. It has a positive effect in many situations, but it can also led to overcorrection for some products. Blue path radiance rescaling is therefore switched off in the default configuration. However, it can be switched on and configured by advanced users in GIP_L2A_AC GIP_L2A_AC.

2.2.3.2.5 Use of external AOT information

Sen2Cor can use meteorological AOT provided globally by the Copernicus Atmosphere Monitoring Service (CAMS) additionally or alternative to AOT retrieval on basis of the DDV-algorithm. The default is to use the CAMS AOT information stored in L1C AUX_DATA folder (since processing baseline 4.0) when the DDV algorithm cannot be applied due to the lack of dark dense vegetation pixels in the image (e.g. desert areas, only water tiles, snowy landscapes)

2.2.4 Aerosol Optical Thickness

AOT retrieval provides a measure for the visual transparency of the atmosphere. It is derived using the DDV (Dense Dark Vegetation) algorithm [5], using the short wave infrared (SWIR) band 12 and correlates its reflectance with bands 04 (red) and 02 (blue). The algorithm requires that the scene contains reference areas of known reflectance behaviour, preferably Dark Dense Vegetation (DDV) and/or dark soil and water bodies.

The algorithm starts with a user-defined visibility (default: 40 km) as input. If the scene contains no dark vegetation or soil pixels, the surface reflectance threshold of band 12 will be successively iterated in order to include medium brightness reference pixels in the sample. If the scene contains no reference (< 1%) and no water pixels, then, since Sen2Cor Version 2.10 a fall-back solution based on CAMS Data is implemented, which requires Level 1C processed input data based on PSD-Version **4.00** and above. This algorithm is further specified in subsection 2.2.4.1 below. If no CAMS data are available, the scene is processed with the starting visibility instead and the algorithm delivers an AOT map as shown in Figure 2-9 below.

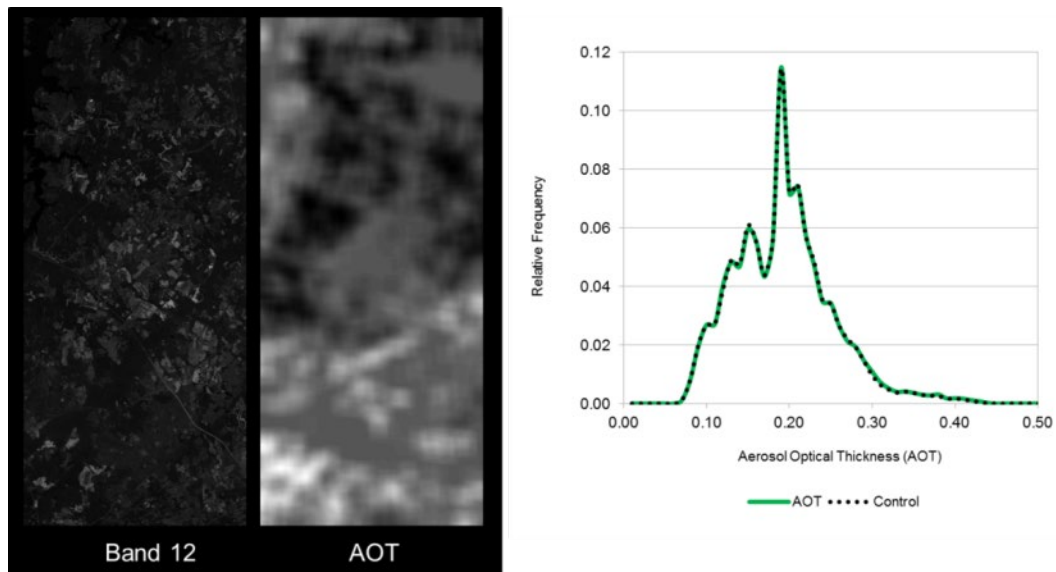

Figure 2-9 – AOT Retrieval using Band 12

2.2.4.1 AOT Retrieval based on CAMS Data

In case of absence of the aforementioned reference pixels for the calculation of the visibility in the region of interested, Sen2Cor Version 2.10 makes use of auxiliary data provided in the Level 1C product. These data are located in the L1C folder ".../GRANULE/.../AUXDATA/" in a binary file called AUX_CAMSxx where xx changes according the method used to derive the data. This file contains a coarse grid (e.g. 9x9) that is representative of the whole tile. Among the included additional auxiliary information, the values of the aerosol optical thickness at 550 micron, "aod550", and the geopotential, "z", proper of the selected region of the tile are retrieved from this grid. Table 2-3 reports the auxiliary input variable in the AUX_CAMS file.

Table 2-3 – CAMS auxiliary input

Variable	Purpose in L2A processing context	Raster Band Number
Geopotential (z)	To retrieve the visibility map/index	1
Total Aerosol Optical Depth at 469nm	unused	2
Total Aerosol Optical Depth at 550nm	To retrieve the visibility map/index	3
Total Aerosol Optical Depth at 670nm	unused	4
Total Aerosol Optical Depth at 865nm	unused	5
Total Aerosol Optical Depth at 1240nm	unused	6
Black Carbon Aerosol Optical Depth at 550nm	unused	7
Dust Aerosol Optical Depth at 550nm	unused	8

Variable	Purpose in L2A processing context	Raster Band Number
Organic Matter Aerosol Optical Depth at 550nm	unused	9
Sea Salt Aerosol Optical Depth at 550nm	unused	10
Sulphate Aerosol Optical Depth at 550nm	unused	11

The visibility is then computed by applying the formula provided by DLR/ATCOR and a visibility band is created. The associated ATBD describes how the computed visibility is then used for the atmospheric correction. If none of the CAMS data is available, the visibility is taken from starting value present in the input data.

2.2.5 Water Vapour Retrieval

WV retrieval over land is performed with the Atmospheric Pre-corrected Differential Absorption algorithm (APDA, [6]) which is applied to the two Sentinel-2 bands B8a, and B9 (see Figure 2-10). Band 8a is the reference channel in an atmospheric window region. Band B9 is the measurement channel in the absorption region. The absorption depth is evaluated by calculating the radiance for an atmosphere with no WV, assuming that the surface reflectance for the measurement channel is the same as for the reference channel. The absorption depth is then a measure of the WV column content. WV estimation is performed for the default processing baseline. It can be switched off by the user in the configuration file L2A_GIPP.xml located in the Sen2Cor home directory of the user. The user has several options to configure how water pixels are filled with WV-values. Default is to use the scene average of water vapour column for water pixels. The user can change the length of square box for smoothing the WV map.

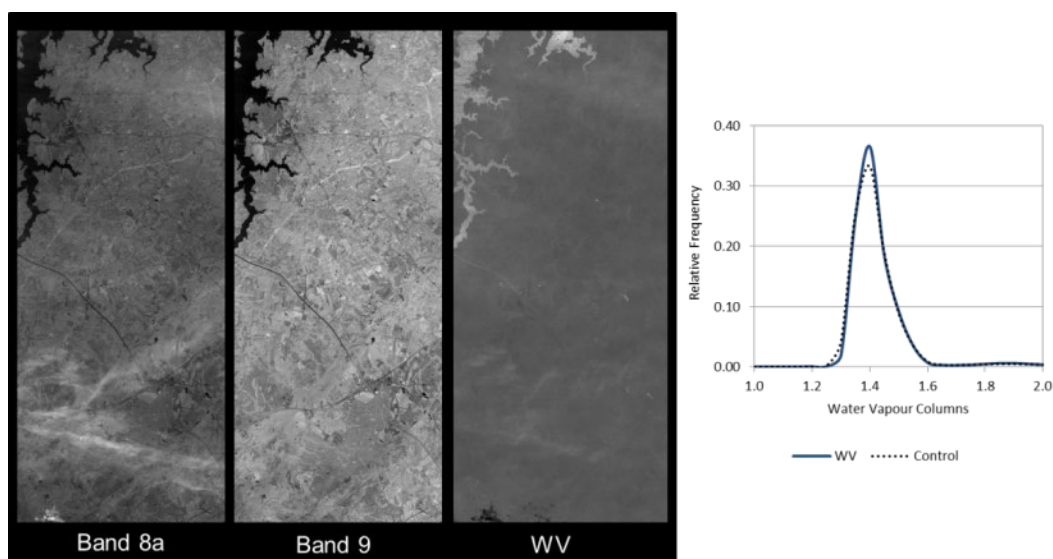

Figure 2-10 – WV Retrieval using Bands 8a and 9

2.2.6 Cirrus Correction

The Cirrus Correction algorithm uses the sentinel (cirrus) channel 10. Thin cirrus clouds affect the visible, near- and shortwave infrared spectral regions. They are partially transparent and thus difficult to detect with broad-band multispectral sensors, especially over spatially inhomogeneous land areas.

WV, in contrast, dominates in the lower troposphere of 0-5 km. A narrow spectral band in a spectral region of very strong WV absorption (Band 10) will thus absorb the ground reflected signal, but will receive the scattered cirrus signal.

Cirrus reflectance of band 10 can therefore be correlated with other bands in the VNIR and SWIR region and the cirrus contribution can thus be removed from the radiance signal to obtain a cirrus-corrected scene. This is shown in Figure 2-11 below as a qualitative result.

Very good results can be achieved locally for a great visual impact however it is not activated by default because on a global scale the results of cirrus correction cannot be always optimal. The option can be activated by the user. Please note that cirrus correction is only applied during 20 m and 60 m processing. It is not applied at 10 m.

If cirrus correction is activated, then it can be influenced by a threshold based on the average water vapour column of a scene. Band 10 might become partly transparent for very low water vapour values or higher elevated surfaces leading to misinterpretation of bright surfaces as cirrus in the 1.38 μm band. Cirrus correction will therefore not be performed if average water vapour column of the scene is less than that threshold.

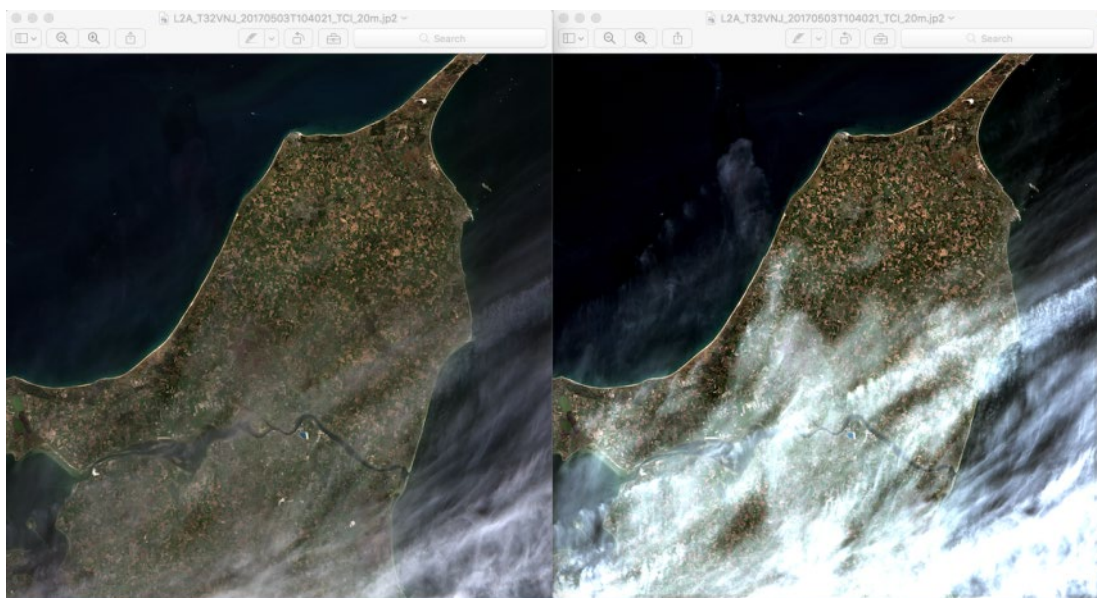

Figure 2-11 – Cirrus Correction over north Denmark, Bands 2-4 with Band 10. Left: L2A Output cirrus corrected, right: without correction.

2.2.7 Surface Reflectance Retrieval

Surface Reflectance retrieval is performed for each sequential Band B1 – B12. Figure 2-12 below shows the Level 1C input data and the corresponding Level 2A

output after atmospheric correction from a scene of La Paz, retrieved on 28.03.2016.

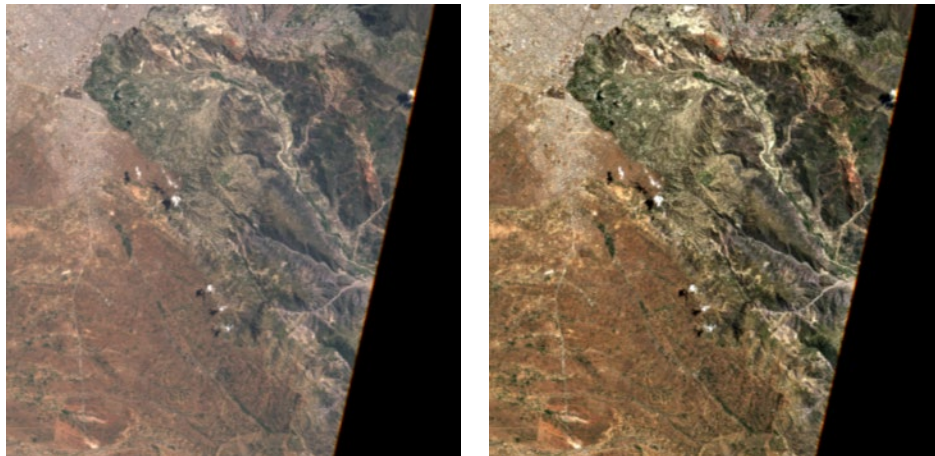

Figure 2-12 – Left: Level 1C Input, Bands 2-4; right: Level 2A Output, Bands 2-4, RGB composite images, scene from La Paz on

2.2.8 Usage of Digital Elevation Maps

Since the release of Sen2Cor 2.2, Digital Elevation Maps can be used for two purposes:

1. Improvement of the scene classification: previous versions of the processor had a tendency of false classification of water pixels inside of cloud borders and the correct discrimination between topographic and cloud shadow pixels. This was improved by taking the height information of an (optional) digital elevation map (DEM) as an additional input. To use this feature it is necessary to activate the reading of an appropriate DEM as is explained below.
2. Improvement of the terrain correction for rugged terrains: the algorithm for rugged terrain requires the existence of an appropriate Digital Elevation Map (DEM) and a set of derived products like slope, aspect and terrain shadow maps. The retrieval of the water vapour map also includes this terrain elevation.

Sen2Cor is currently prepared to make use of three different DEM's. The first one is the **90m SRTM Digital Elevation Database from CGIAR-CSI**. Before you decide to make use of this database, please read carefully the Disclaimer given on <https://srtm.csi.cgiar.org/disclaimer/>

The second supported format is the commercial 90m DTED-1 Format from **PlanetDEM** (used for L1C processing in Sentinel-2 ground segment up to L1C PB 02.09): <https://planetobserver.com/global-elevation-data/>

The Planet DEM is not freely downloadable and must be purchased. The processor expects all the appropriate DEM files with the form: *eXXX_nYY.dt1* in the specified local folder and uses them, if available.

The third supported format (New Feature in Sen2Cor 2.10) is the Copernicus DEM. Please refer to the following link for more information:

[Copernicus DEM - GISCO - Eurostat \(europa.eu\)](https://ec.europa.eu/eurostat/tgm/table.do?tab=table&init=1&language=en&code=sdg_11_6_2018)

The usage of a DEM is not set by default. It has to be set manually. **The user can specify a DEM in the L2A_GIPP.xml configuration file** by setting the parameter for `<DEM_Directory>` to a relative path, instead of NONE. The DEM shall be located in the specified folder in the Sen2Cor home directory.

Example: `<DEM_Directory>dem/srtm</DEM_Directory>`

If no appropriate DEM is found in this folder, the processor can try to retrieve DEM files from the selected address. The processor will start automatically to download the DEM's from the database that has to be referenced by:

`<DEM_Reference>`

http://srtm.csi.cgiar.org/wp-content/uploads/files/srtm_5x5/TIFF/

`</DEM_Reference>`

Please be aware that in order to use the srtm, the DEM reference has always to be set, even if the DEM are already available. If the necessary DEM file is found in the local folder defined by `<DEM_Directory>`, the download will not take place and the local archive will be used instead. If the download fails and no local DEM are found, the processor continues with a flat surface calculation.

For the new supported Copernicus DEM:

Example: `<DEM_Directory>dem/copernicus</DEM_Directory>`

`<DEM_Reference>`

<http://xxx.xx.xx>

`</DEM_Reference>`

NOTE: The link will be provided with a dedicated news on STEP and this document will be then updated following up the published news. Please be sure to have the correct reference and folder so to avoid mixing between the srtm and Copernicus, for example.

The Copernicus DEM option also uses an external list of missing tiles (i.e. region of the globe that are not covered by the Copernicus DEM. This file named: CopernicusDEM_90_TIFF_missing_tiles.list is (should be) located in the directory: `'$SEN2COR_BIN/aux_data/`.

New Feature for Sen2Cor 2.9.0 **`<Force_Exit_On_DEM_Error>`**: if an error occurs in the downloading of a DEM or if no DEM can be found, the default behaviour of the algorithm is as described before. If this parameter is set to **TRUE**, the processor will now stop processing instead and exits with an error message. The default configuration is **FALSE**, which leads to the processing behaviour as it was in the previous versions.

The geo-coordinates and angular information are obtained from the Level-1C metadata. The area of interest is created and fitted to the input images according to the information retrieved from the metadata and the conversion is performed using the GDAL libraries from OSGEO.

The algorithm reformats, resamples and assembles the DEMs based on the geo locations obtained either from the Level-1C metadata or from the JPEG-2000 images. Finally, it creates the according slope, aspect and a hill shadow maps using the GDAL DEM tools.

The retrieval of the spectral reflectance cube consists of the following steps:

1. iterations for terrain reflectance;
2. (optional) empirical BRDF correction;
3. adjacency correction;
4. spherical albedo correction.

Figure 2-13 below shows a comparison of the Level 2A output without usage of a DEM and the corresponding Level 2A output when a 90 m CGIAR DEM is applied before terrain correction. The same scene as for Figure 2-12 is shown.

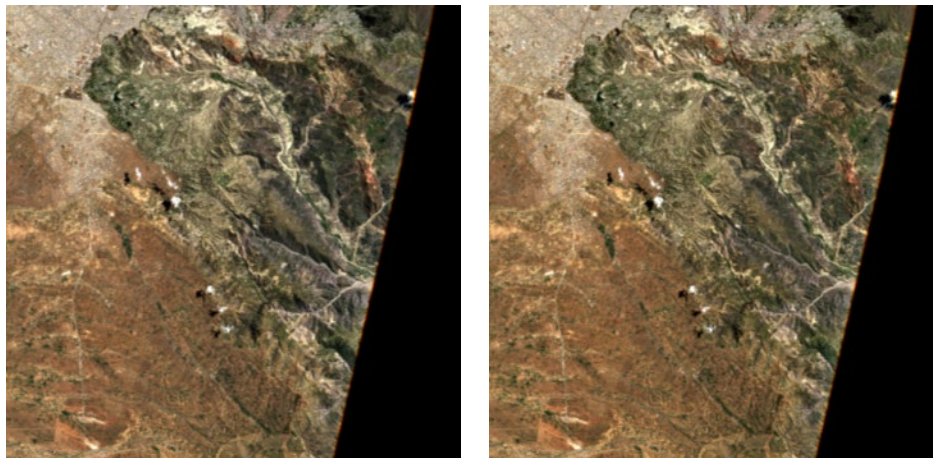

Figure 2-13 – Terrain correction; Left: Level 1C Input, Bands 2-4, RGB composite image, middle: DEM, reshaped to according scene, right: Level 2A Output, Bands 2-4, RGB composite image.

Since Sen2Cor V.2.3.0 (PFS 14.2) an offset of 10.000 is added to the DN output Value of the DEM array in order to support negative heights, as the OpenJPEG format only supports unsigned integer values. In practice, the highest elevation value on Earth: ~8,848 m and lowest elevation value on dry land: ~ -418m are thus encoded as 18848 and 9582 DN.

Since Sen2Cor 2.7.0: to decouple the DEM processing between scene classification, AOT and terrain correction a new configuration parameter has been inserted in the L2A_GIPP.xml. Setting `<DEM_Terrain_Correction>` to 'FALSE' will disable the terrain iteration for the terrain corrections, whereas scene classification, AOT (and WVP) are still calculated using the DEM information.

2.2.9 Quality Mask

Sen2Cor 2.10 introduces the possibility to apply a quality mask to the tile so to remove all the problematic pixels that a given band may carry. This option is activated in the L2A_GIPP.xml by setting 'TRUE' the entry `<Handle_L1CQLT_Mask>`.

More information on the way Sen2Cor 2.10 handles the necessary input is available in the associated [IODD]. Figure 2-14 shows an example of a L2A product where a quality mask is applied.

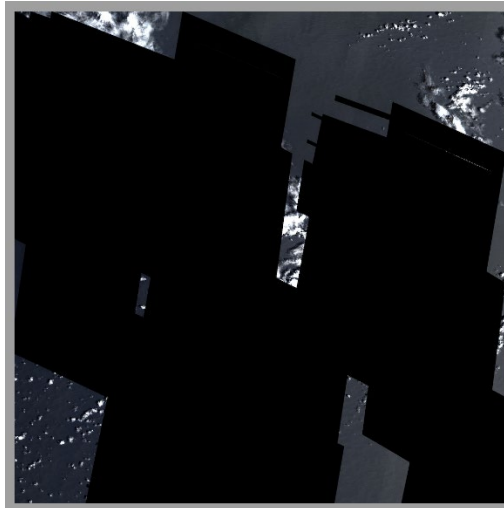

Figure 2-14 – L2A TCI image of a tile processed with a Quality Mask masking defective pixels of different affected bands.

2.3 Product Formatting

The Level 2A Product format is closely related to the Level 1C Top-of-Atmosphere (TOA) reflectance product which serves as an input to the processor (see Figure 2-15). It consists of 13 JPEG-2000 images, associated to the 13 Sentinel-2 spectral bands at three different spatial resolutions with a ground sampling distance of 10, 20, and 60m.

The generated Level 2A BOA reflectance output images are resampled and generated with an equal spatial resolution for all bands, based on three user selectable resolutions of 10, 20 and / or 60m.

The tile level contains different components, based on the user selected resolution:

- a 10 m resolution product contains spectral bands 2, 3, 4 and 8 and an AOT map resampled from 20m
- a 20 m product contains band 1 – 7, the bands 8a, 11 and 12 and an AOT and WV map
- a 60m product contains all components of the 20m product and additionally the 60m bands 1 and 9
- Additionally, starting with Sen2Cor 2.3.0 a True Colour composite Image (TCI) using Bands 2-4 with the same resolution as the monochrome bands will be stored in parallel to the reflectance output images.
- The Cirrus band 10 will be omitted in the Level 2A output, as it does not contain surface information.

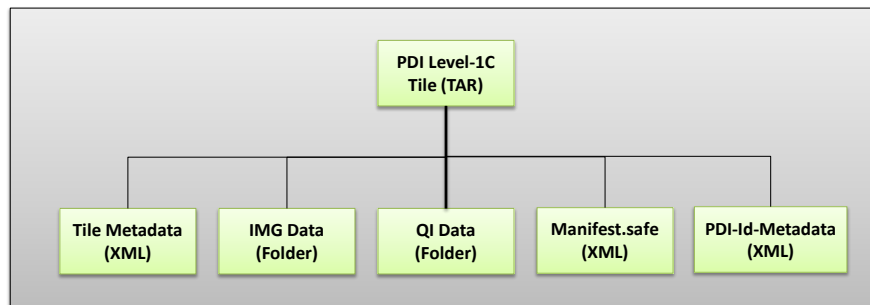

Figure 2-15 – Filing structure of Level-1C product on tile level

The complete specifications for all inputs are provided in [S2-PDGS-MPC-L2A-PFS] and [S2-PDGS-MPC-L2A-IODD]. Level-2A Inputs are derived from the Level-1C data schemes as described in [S2-PFS].

2.4 Runtime Configuration

Ground Image Processing Parameter (GIPP) are configured in an XML file named L2A_GIPP.xml, located in the <cfg> subdirectory of the processor (see example in the appendix), where they can be configured by the user. The GIPP are listed in their current context. These parameters, together with all input, output and other auxiliary data are listed in the corresponding [S2-PDGS-MPC-L2A-IODD] document and thus not repeated here.

2.4.1 Pre-processing (L2A_Tables)

The Level-1C input data is expected to be present in a folder structure at product level, as specified in section 3.1 of [L2A-PDD]. The location of the Level-1C input product can be specified via the command line argument.

Due to the three different resolutions of the Level-1C input images, conversion routines will serve for an up- and down- sampling of parts of the images into the appropriate resolution as well as the transfer from JPEG-2000 into a different internal format (see below). This has been implemented using the OpenJPEG library, which will be installed during the Sen2Cor setup.

Due to the relative huge size of the image data (especially for the high-resolution 10 bands B02 – B04 and B08) data in and output has been shown as rather time and memory consuming.

Since Sen2Cor 2.8.0: OpenJPEG, version 2.3 which is used for the reading of the L1C input images now allows the usage of multithreading to speed up the import. The configuration is set by default to AUTO in the L2A_GIPP.xml configuration file (see [S2-PDGS-MPC-L2A-IODD]), which detects the amount of usable threads by calling `cpu_count()`. If the user does not want this feature or want to set the amount of threads individually, the parameter <Nr_Threads> can be changed between a value of 1 (single thread processing) up to 8. Figure 2-16 below shows the speed improvement for reading on a 2 Core Intel I5 platform with 8 GB of RAM between OpenJPEG 2.1 (left) and (new) OpenJPEG 2.3 with one, two and four threads applied.

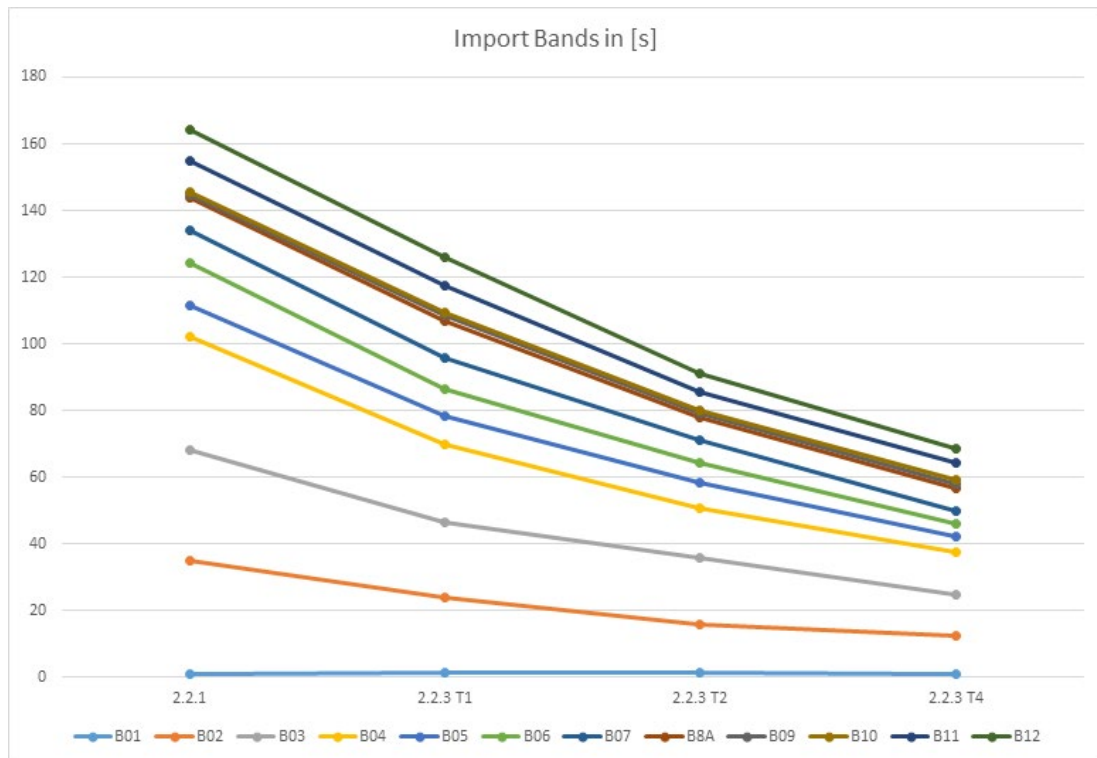

Figure 2-16 – Performance improvement using OpenJPEG 2.3 and multithreading

An intermediate data conversion was selected which converts the JPEG-2000 images and the necessary metadata (like the DEM) into an internal format based on HDF5. HDF5 is a data model, library, and file format for storing and managing data. It is especially designed for flexible and efficient I/O and for high volume and complex data. HDF5 is portable and extensible, allowing applications to evolve in their use and platforms to be supported.

The interfacing with the internal data format is implemented via PyTables. PyTables is a package for managing hierarchical datasets, designed to efficiently handle extremely large amounts of data. It is built on top of the HDF5 library, the Python language and the NumPy package. PyTables and HDF5 are described in section 5. Since Sen2Cor 2.7.0 and above: operations with Sen2Cor 2.6.3 in the PDGS mode have shown that the HDF5 database could grow up to more than 5 GB for a full tile, using DEMs as additional auxiliary data. To downscale the consumption of disk space the following modifications have been implemented with 2.7.0:

- There is now a persistent image database containing only the L1C source files in their default resolutions. This database will be first removed after a full processing of all resolutions. Additionally, a temporary database is filled with the resampled and generated products, which will be removed after each processed resolution in order to keep the space of the databases to the lowest limit possible.
- In PDGS mode, a new command line option allows specifying the two locations of the image and the temporary database. Two different user selectable locations are available in order to select between the separate usage of a ramdisk and a normal disk space. The configuration is performed via command line (see section 3.3.1). By default, the databases will be

created in the working directory given via command line. Toolbox users can ignore this option. In Toolbox mode the database will always be located in the corresponding tile directory. The options will have no effect.

- There is also a configurable compression factor available in the User configuration file L2A_GIPP.xml (<Database_Compression_Factor>, see [S2-PDGS-MPC-L2A-IODD] for details). For PDGS operations, it is recommended to use a compression factor of 1, which allows a reduction of the databases to about 2/3 of their original size in the non-compressed mode whereas for TOOLBOX users the proposed default setting is no compression (compression factor of 0) to get a better speed performance.
- In the first processing stage, the image database will load only the bands needed for the 20 m processing (except 10 m Band 8). After the 20m processing is performed, all bands (except the three 10m bands 1-3) are removed and Band 8 will be loaded. Thus, the database will keep a size below 1 GB during the whole processing.
- The temporary database will import all auxiliary data (like the DEMs and ESACCI images). It will additionally store the resampled bands from the image database and the processed products from the 20 m Scene Classification (Classification Map) and Atmospheric correction (AOT/Visibility and Water Vapor). After the 20 m processing is performed, only these products will be up-sampled to 10 m and copied into a new temporary database. The old database, with all products no longer needed, will then be removed.
- In the 10 m processing the temporary database keeps the AOT/Visibility and Water vapor and imports the new resampled auxiliary data, needed for the 10m processing.
- The down-sampling routine to 60 m has been improved in the way that the output products will be directly converted to their final format, so that no further storage of these down-sampled products in the database is required.
- Additionally, all bands that are no longer needed for the processing chain are removed from the temporary database, to free space for other intermediate products.

Given these improvements, the following measures have been obtained by operation of a full sized L1C tile with configured DEM, processing for 20m and 10m and a down sampling of the 20m product to 60m.

Resolution	Image DB	Temp DB
20 m processing	739 MB	1.53 GB
Down sampling to 60	No changes in DB size	No changes in DB size
10 m processing	867 MB	1.963 GB

Please note (!): the 10m processing uses some parts of the outputs from the 20m processing (Scene Classification, Aerosol Optical Thickness, Water Vapour and Visibility). In addition, both processing steps use the same bands located in the image database. Thus, although it is possible to address two different locations for the image and the temporary database, it is very important that the location for

the individual database keeps the same for the two processing steps and that both databases are not removed externally. The processor itself will keep care for the proper housekeeping of the two databases.

2.4.2 Improvement of the Processing Routines

Since Sen2Cor 2.6.0: the routines for generating user products of different resolutions have been decoupled and generally improved:

- Sen2Cor will now read all required bands only once, at begin of the processing in their original resolution. For each subsequent processing, the bands will be internally resampled and written to the target resolution.
- If the user is specifying no resolution at all on the command line, first the 20m and in a second step, the 10m resolution will be processed.
- Since Sen2Cor 2.6.5 and above: starting with Version 2.6.5 the user can configure an optional down sampling to a 60m resolution, after a 20m processing has been performed. This is configured via the entry <Downsample_20_to_60> in the L2A_GIPP configuration file.
- If the user instead explicitly wants to process a 60m resolution, this can be performed still via the option --resolution=60 in the command line. In the same way a 20 or 10m resolution processing can be selected.
- The selection of a 10 m resolution requires the generation of a 20 m product. This will be processed first, if the 10 m option is chosen.

Since Sen2Cor 2.9.0, two features for improving the processing time have been implemented: **Manual Configuration** and **Auto Detection** of a **<Region_Of_Interest>**. This can be configured in a new section of the L2A_GIPP configuration file:

- **Manual configuration:** it is now possible to specify a rectangle around a midpoint coordinate, which is given by the **row0** and **col0** parameters, and the size of the rectangle given by the **nrow_win** and **ncol_win** parameters around the midpoint. Processing will then only take place in this region (See Figure 2-16 – Manual configuration of a 3000 x 3000 frame window. Absolute processing time in minutes and percentages between full processing and sub-tile.). The values are always expected to be configured within a whole frame of 10980 x 10980 pixels. This corresponds to a full tile at 10m resolution. The sizes need not to be identical, but the ROI **must** be located inside of the whole frame and all given values **must** be integer divisible by six, in order to prevent rounding errors for the lower resolutions of 20m and 60m.

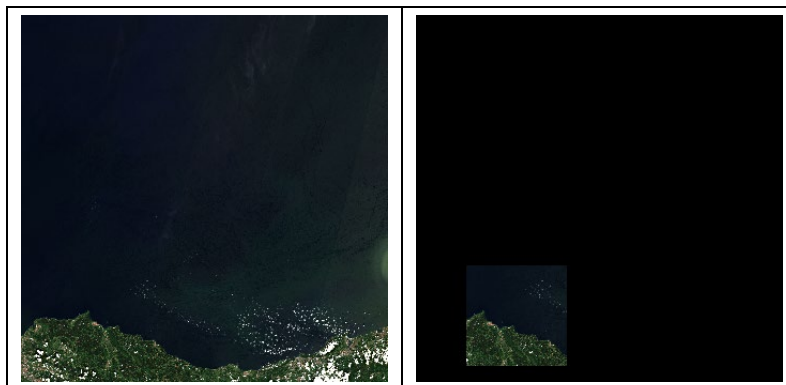

Tile size: 10980 x 10980	Tile size: 3000 x 3000
Processing time: 22:35	Processing time: 03:22
%: 100	%: 15

Figure 2-17 – Manual configuration of a 3000 x 3000 frame window. Absolute processing time in minutes and percentages between full processing and sub-tile.

- Automatic ROI Detection:** this option shrinks the processing only to those rectangular areas of a tile that contain foreground pixels. if row0 (and col0) are set **AUTO** the area of interest is detected automatically: this is given by the min and max rows and columns, where a non-background pixel can be found and will reduce processing time, as the rectangular areas containing only background pixels are not included in the processing.
 If row0 (and col0) are set to **OFF**, the standard processing will take place without checking whether the processing area can be shrunk. Also, if the processing mode is set initially to AUTO and a full tile is detected, the processing is switched to the standard mode. If AUTO or OFF are selected, the values for nrow_win and ncol_win are ignored.

The Figure 2-18 – Tests on Autodetection. Absolute processing time in minutes and percentages between full processing and auto mode) shows a comparison of the processing times for three selected tiles with different amounts of background pixels.



		
Full: 17:30 Auto: 03:05 %: 18	Full: 20:24 Auto: 12:37 %: 62	Full: 10:62 Auto: 04:13 %: 40

Figure 2-18 – Tests on Autodetection. Absolute processing time in minutes and percentages between full processing and auto mode

2.4.3 The 60 m Product Processing

The 60m product processing uses the three 60m bands B01, B09 and B10 and a 60m DEM as inputs. The three 10m bands B02-B04 will be internally down-sampled to 60m. The same is true for the 20m bands B05 – B8A and B11, B12. The 10m band B08 is not used for the 60m processing.

Beneath the twelve optical channels (the cirrus channel B10 is excluded, as it does not represent surface information) the 60m product processing generates:

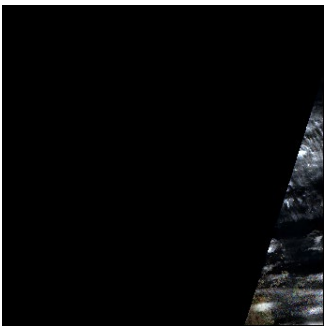
1. a Scene Classification map (SCL);

2. quality indicators for presence of snow and clouds (in percentage);
3. an Atmospheric Optical Thickness (AOT);
4. a Water Vapour map (WVP);
5. a preview image, covering the three visible bands 2-4 within an JPEG-2 compressed image, at 320m resolution.

2.4.4 The 20 m Product Processing

The 20m product processing uses the 20m bands B05 – B8A and B11, B12 and a 20m DEM as inputs. The three 60m bands B01, B09 and B10 will internally be up-sampled to 20m, the three 10m bands B02-B04 will be internally down-sampled to 20m. The 10m band B08 is not used for the 20m processing.

The 20m product processing covers nine optical channels a 20m AOT and a WV and a Visibility Index file corresponding to the AOT. The two resampled 60m bands B09 and B10 are omitted in the output in order to avoid spectral artefacts due to mixed signatures and resampling.

2.4.5 The 10 m Product Processing

Inputs for the 10m product processing are the four 10m bands B02-B04 and B08, an optional 10m DEM an up-sampled Scene Classification and a Visibility Index map, both up-sampled from 20m. As the WV influence is very small, only the scene-average WV needs to be used for the surface reflectance retrieval. The 10m product processing covers thus only four optical channels. The other channels, not used for the calculation will be omitted. Always, a 20 m resolution needs to be performed first, as the 10m processing depends on these input data.

2.4.6 Post-Processing

The OpenJPEG Library is used for generating the final L2A-Product, transferring the internal HDF5 based tables back into the JPEG-2000 format. It keeps for all generated products the final (resampled) resolution.

The output product will be placed in the folder addressed via the option "--output_dir". If this option is omitted, the output product will be placed in the same folder as the Level-1C input product.

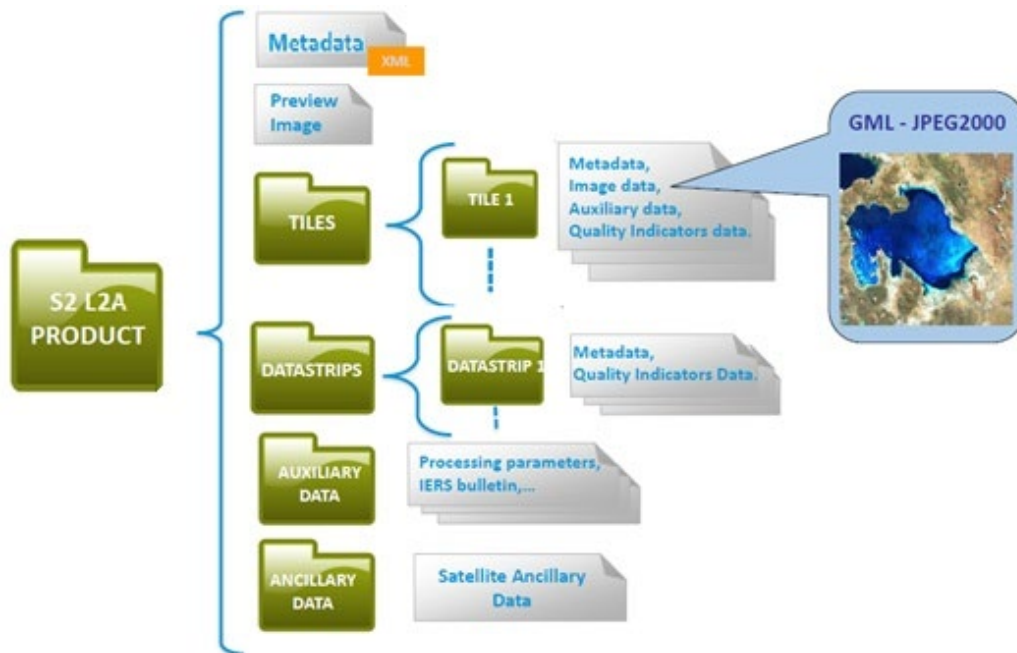

Figure 2-19 – Level 2A product, physical format Configuration (L2A_Config)

2.4.7 Configuration recommendations

ESA-L2A core product is the L2A-generation performed in the S2-PDGS, which can be downloaded from OpenHub [<https://scihub.copernicus.eu/dhus/>]. It is based on processor version and default configuration valid at time of processing. Consequently this ESA archive is no 'collection' providing a (long) homogenous time series. Rely on 'user' product if no homogenous time series is available. 'User' production with toolbox version gives also opportunity to process with non-default configuration.

The recommended baseline processing is the rural/continental aerosol type together with the summer atmospheric profile, but it can also be specified according to geography and climatology. However, a change of the aerosol type and profile between successive scenes may cause brightness steps in the BOA reflectance at scene borders and should be avoided. It is also recommend forcing aerosol type and season to the same configuration for processing of time series. The baseline configuration for the selection of ozone content is to retrieve the information from the L1C auxiliary meteorological file from ECMWF.

AOT estimation can be configured by the user in the configuration file L2A_GIPP.xml located in the Sen2Cor home directory of the user. SEN2COR supports configuration of the start visibility, the visibility update mode and the aerosol model.

The visibility set in the configuration file is used multiple times. It is used as a start visibility which serves for computing the surface reflectance in the SWIR2-band for DDV detection. It can be used as fall-back solution if there are no DDV-pixels in the granule or it gives the value to be used if processing with fixed AOT was configured. Default setting for visibility is 40 km which corresponds to AOT550 of about 0.20 at sea level. To set the correct mean altitude for the granule is important for AOT retrieval if no DEM is provided.

The user can configure Sen2Cor to work with a fixed, constant visibility, to update the start visibility with the DDV-algorithm (default), to use only meteorological AOT from ECMWF or to merge visibility update of the DDV algorithm with using meteorological AOT from ECMWF. The user can select the fall-back solution to be applied. Default is using meteorological AOT from ECMWF as fall-back solution.

The recommended baseline for processing selects the fixed aerosol type rural / continental. For smaller areas (such as specific islands) it may be interesting to switch to using a maritime aerosol. The user can alternatively select the automatic aerosol type selection.

Recommendation is to employ a fixed aerosol type for a production tessellating multiple granules or for processing time series. Keeping aerosol type fixed may decrease the Surface Reflectance accuracy for some atmospheric conditions, however differences in surface reflectance due to processing with different aerosol types are understood to be smaller than uncertainty in AOT. Fixed aerosol type gives priority to the homogeneity of the result. Possible switching of aerosol types between successive scenes due to automatic aerosol type selection (or within the set of tiles for one scene) in a Sentinel-2 trajectory can cause brightness steps at the scene / tile borders. Fixed aerosol type avoids bumps in time series when changing aerosol type resulting in better time-series overall consistency.

Advanced users find also configuration options for the blue path radiance rescaling in the L2A_CAL_AC_GIPP.xml. Blue path radiance rescaling is switched off in the default configuration of Sen2Cor. It can be switched on and the rescaling can be limited to corrections lower than 10%.

2.5 Memory Requirements

The atmospheric correction processing for 10m resolutions uses a large amount of memory due to the 10.000 x 10.000 pixel for each image. Multiple images must be kept at certain intervals completely in memory for performing correlations.

Figure 2-20 shows the memory consumption for a full Sen2Cor processing using a MacBook Pro, mid 2014, with a 2.8 GHz Dual-Core Intel Core i5 processor and with 8 Gb 1600 MHz DDR3. Although the peak is reached at 3.5 GB, as a general rule, a resource of **4 GB of memory** should be at least available for processing at 10m resolution.

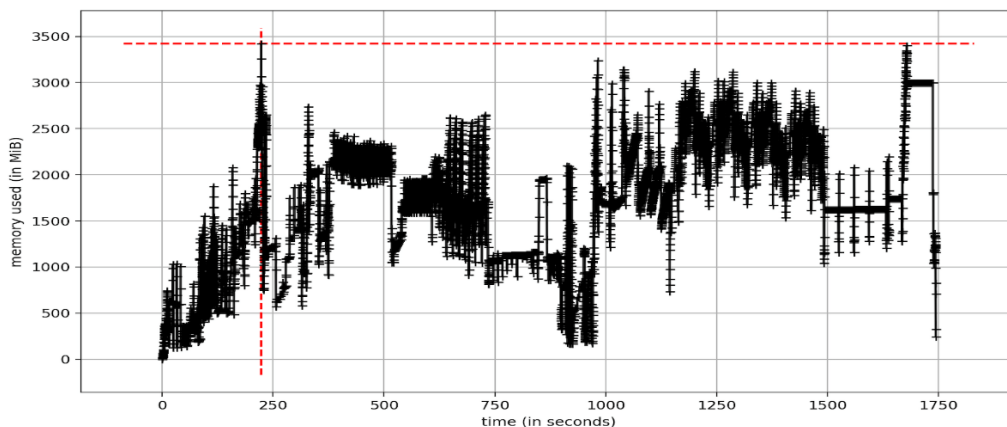

Figure 2-20 Memory Consumption during processing

2.6 Interface changes:

Configuration: the L2A_GIPP.xml has been rearranged. Only user specific configuration parameters are presented. Expert configuration parameters have been moved into 2 configuration files which are located under the site-package directory of the Sen2Cor application.

L2A_CAL_SC_GIPP.xml: contains the calibration parameter for the scene classification which should only be changed by expert users. Thus, this file is no member of the user configuration.

L2A_CAL_AC_GIPP.xml: contains the calibration parameter for the atmospheric correction which should only be changed by expert users. Thus, this file is no member of the user configuration.

Starting with Version 2.3.0 the following four changes in the configuration have been added.

Configuration Item	Description	Value
Scaling_Limiter	limits the scaling of the path radiance for the blue channel to +/-10%.	true (default)/ false
Scaling_Disabler	Disables the scaling of the path radiance for the blue channel.	true (default) / false

Configuration Item	Description	Value
Rho_Retrieval_Step2	Disables the execution of step 2 of the	true (default) / false

As these configuration items are of experimental character they are located in the expert configuration file L2A_CAL_AC_GIPP.xml and should not be changed by standard users.

In the user configuration file L2A_GIPP.xml (located in the cfg directory of the directory where \$SEN2COR_HOME points to) the default value for the visibility has been changed from 23 to 40 km.

Configuration Item	Description	Value
Visibility	Sets the visibility default value	40.0 (default)

Starting from version 2.10 the L2A_GIPP.xml contain the necessary updates for handling the PSD version 14.9. Moreover, new entries comprise the <DOI> (Digital Object Identifier) and the <Handle_L1C_QLT_Mask> option. For this last aspect, please refer to the [IODD] and the new section 2.2.9.

2.6.1 Other Changes:

As new L2A user product will always be created with the current timestamp in UTC for the creation time.

- A selected resolution of 60 m will only process the 60 m resolution.
- A selected resolution of 20 m will only process the 20 m resolution.
- A selected resolution of 10 m will process the 20 m resolution first, as it is the base for the 10 m product.
- If the option <Downsample_20_to_60> in the L2A_GIPP.xml is set to TRUE, a 60 m product will be generated via a down sampling of the 20 m product. This is configured by default and can be changed in the L2A_GIPP.xml.

2.7 Logging (Logger)

The module L2A_Config keeps an instance of a logger object. Each of the processing modules writes its own diagnosis and status messages into a common log-file, located in the HTML folder at the top of the User product.

The log level can be configured in the GIPP (L2A_GIPP.xml) as:

DEBUG, INFO, WARNING, ERROR, CRITICAL, NOTSET

The log-level is hierarchical: if e.g. set to **DEBUG**, all higher messages such as **INFO**, **WARNING**, **ERROR** or **CRITICAL** will be displayed as well. Setting the log-level to **ERROR** displays only **ERROR** and **CRITICAL** messages.

Beneath the message itself, the logger displays the system time stamp when the message was generated, the log-level, the module which has generated the message and the function and code line of the module which has generated the message.

Since Version 2.6.0 the formatter of the logging output has been aligned to the Level 1C processor (only for PDGS mode).

3. Configuration and Installation

3.1 Installation and Setup

Installation and Setup of the runtime environment is specific on the actual releases of Sen2Cor and is described in the according release note under Section 4.

3.1.1 ESACCI-LC package for SC module

The ESACCI-LC for Sen2Cor data package is prepared for users of Sen2Cor version ≥ 2.5 who want to benefit from the last improvements of Sen2Cor Cloud Screening and Classification module. This auxiliary data information is used in Sen2Cor to improve the accuracy of Sen2Cor classification over water, urban and bare areas and also to have a better handling of false detection of snow pixels.

Please note that a Digital Elevation Model (DEM) is a pre-requisite for using ESACCI_LC information in the Scene Classification algorithm. Please refer to section 2.2.7 to use an external DEM. In the case SRTM DEM is used, latitudes higher > 60 deg N (and lower < 56 deg S) are not covered by the SRTM DEM, therefore no ESACCI_LC information will be used for these latitudes. Standard Scene Classification algorithm will then be applied.

Users of Sen2Cor version 2.10 should download the new monthly snow condition files derived from ESACCI from this [location](#).

The zip file shall then be extracted at this location of Sen2Cor installation:

``$SEN2COR_BIN/aux_data/``.

It contains two files and one directory:

- **ESACCI-LC-L4-LCCS-Map-300m-P1Y-2015-v2.0.7.tif**
- **ESACCI-LC-L4-WB-Map-150m-P13Y-2000-v4.0.tif**
- **ESACCI-LC-L4-Snow-Cond-500m-MONTHLY-2000-2012-v2.4**

Users of Sen2Cor version < 2.10 should download this ESACCI-LC for Sen2Cor data package (ESACCI-LC-L4-ALL-FOR-SEN2COR.zip) from this location: <http://maps.elie.ucl.ac.be/CCI/viewer/download.php>

This zip file shall then be extracted at this location of Sen2Cor installation: ``$SEN2COR_BIN/aux_data/``. It contains two files and one directory:

- **ESACCI-LC-L4-LCCS-Map-300m-P1Y-2015-v2.0.7.tif**
- **ESACCI-LC-L4-WB-Map-150m-P13Y-2000-v4.0.tif**
- **ESACCI-LC-L4-Snow-Cond-500m-P13Y7D-2000-2012-v2.0**

Example on Ubuntu (Linux) installation:

```
$ ls Sen2Cor-02.10.00-Linux64/lib/python2.7/site-packages/sen2cor/aux_data  
ESACCI-LC-L4-LCCS-Map-300m-P1Y-2015-v2.0.7.tif  
ESACCI-LC-L4-Snow-Cond-500m-MONTHLY-2000-2012-v2.4  
ESACCI-LC-L4-WB-Map-150m-P13Y-2000-v4.0.tif
```

Example on Windows7 installation:

```
>dir Sen2Cor-02.10.00-Linux64/lib/python2.7/site-packages/sen2cor/aux_data
ESACCI-LC-L4-LCCS-Map-300m-P1Y-2015-v2.0.7.tif
ESACCI-LC-L4-Snow-Cond-500m-MONTHLY-2000-2012-v2.4
ESACCI-LC-L4-WB-Map-150m-P13Y-2000-v4.0.tif
```

Note: Please note that it is possible to use symbolic links in this aux_data folder if you prefer to copy those auxiliary files to another data folder. (unix command: ln -s, windows command: mklink)

3.2 Configuration Files

It is important to know that the default configuration of the L2A algorithm provided with Sen2Cor version 02.10 is the same configuration as for the operational L2A processing in Sentinel-2 Ground Segment (S2PDGS) able to process L2A different processing baselines. So no further tuning should be required on user side to get L2A "standard" products as generated by S2PDGS. The only differences between "Toolbox" and "standard" L2A products should either come from the difference in the DEM used (e.g. no DEM, SRTM of PlanetDEM, Copernicus) or from the JPEG2000 encoding, OpenJPEG in Toolbox and Kakadu in "standard" products.

3.2.1 L2A_GIPP.xml

Located under `$SEN2COR_HOME/cfg` the GIPP file of the application (which is an xml formatted file) can be configured by the user for individual purposes. If a different configuration shall be used, '`$SEN2COR_HOME`' directory can be reconfigured to a different directory:

```
export SEN2COR_HOME=' <directory of your choice>
```

This allows the operation with multiple configuration settings. Configuration is part of the [S2-PDGS-MPC-L2A-IODD] and thus not described here.

The new parameters added in the L2A_GIPP.xml for Sen2Cor 2.10 are described in the associated [IODD], and in section 2.6.

Additionally, to these changes for the PDGS mode, three options are provided in the L2A_GIPP.xml file in order to activate or deactivate the generation of three optional output products:

```
<Generate_DEM_Output>FALSE</Generate_DEM_Output>
FALSE: no DEM output, TRUE: store DEM in the AUX data directory
<Generate_TCI_Output>TRUE</Generate_TCI_Output>
FALSE: no TCI output, TRUE: store TCI in the IMAGE data directory
<Generate_DDV_Output>FALSE</Generate_DDV_Output>
FALSE: no DDV output, TRUE: store DDV in the QI_DATA directory
```

Note: the DDV is not an official supported product and is only of interest for expert testing purposes of the algorithm for Aerosol Optical Thickness.

3.3 Operation

The processor can be operated in three different ways:

- either as a purely command line driven application;
- or from the Sentinel-2 Toolbox;
- or as a command line driven application inside the PDGS.

Important! Due to the PDGS extensions Sen2Cor Version 2.10 converts product below PSD 14.6 to 14.6.

3.3.1 Command Line Options since Sen2Cor Version 2.7.0

Typing --help in the console will list all the possible commands/options (See Table below).

The following command line features are implemented **for PDGS support**:

- Support of Datastrip generation mode with L1C input Datastrip;
- Support of Tile processing mode with L1C input Tile;
- L1C Datastrip and Tiles can have either standard SAFE or SAFE compact format as input;
- L2A Datastrip and Tile are formatted in standard SAFE format for output.

The following command line features are 2.10 implementations **for Toolbox**:

- Select the previous algorithm Scene Classification (--sc classic);
- Export the Scene Classification in COG format instead of JPEG_2000 (--sc_cog).

Command Line Parameters ("PDGS" mode processing L1C Datastrip and L1C Tile in sequence)

```
usage: L2A_Process.py [-h] [--mode MODE] [--resolution {10,20,60}]
                    [--datastrip DATASTRIP] [--tile TILE]
                    [--output_dir OUTPUT_DIR] [--work_dir WORK_DIR]
                    [--img_database_dir IMG_DATABASE_DIR]
                    [--res_database_dir RES_DATABASE_DIR]
                    [--processing_centre PROCESSING_CENTRE]
                    [--archiving_centre ARCHIVING_CENTRE]
                    [--processing_baseline PROCESSING_BASELINE] [--raw]
                    [--tif] [--sc_only] [--sc_classic] [--sc_cog]
                    [--cr_only] [--debug] [--GIP_L2A GIP_L2A]
                    [--GIP_L2A_SC GIP_L2A_SC] [--GIP_L2A_AC GIP_L2A_AC]
                    [--GIP_L2A_PB GIP_L2A_PB]
                    input_dir

Sen2Cor. Version: 2.10.01, created: 2021.12.13, supporting Level-1C product
version 14.2 - 14.9.

positional arguments:
  input_dir              Directory of Level-1C input

optional arguments:
  -h, --help            show this help message and exit
  --mode MODE           Mode: generate_datastrip, process_tile
  --resolution {10,20,60}
                        Target resolution, can be 10, 20 or 60m. If omitted,
                        only 20 and 10m resolutions will be processed
  --datastrip DATASTRIP
                        Datastrip folder
  --tile TILE           Tile folder
  --output_dir OUTPUT_DIR
                        Output directory
  --work_dir WORK_DIR  Work directory
  --img_database_dir IMG_DATABASE_DIR
                        Database directory for L1C input images
  --res_database_dir RES_DATABASE_DIR
                        Database directory for results and temporary products
  --processing_centre PROCESSING_CENTRE
                        Processing centre as regex: ^[A-Z_]{4}$, e.g. "SGS_"
  --archiving_centre ARCHIVING_CENTRE
                        Archiving centre as regex: ^[A-Z_]{4}$, e.g. "SGS_"
  --processing_baseline PROCESSING_BASELINE
                        Processing baseline in the format: "dd.dd", where
                        d=[0:9]
  --raw                Export raw images in rawl format with ENVI hdr
  --tif                Export raw images in TIFF format instead of JPEG-2000
  --sc_only            Performs only the scene classification at 60 or 20m
                        resolution
  --sc_classic         Performs scene classification in Sen2Cor 2.9 mode
  --sc_cog             Export SCL image in COG format instead of JPEG_2000
  --cr_only            Performs only the creation of the L2A product tree, no
                        processing
  --debug              Performs in debug mode
  --GIP_L2A GIP_L2A   Select the user GIPP
  --GIP_L2A_SC GIP_L2A_SC
                        Select the scene classification GIPP
  --GIP_L2A_AC GIP_L2A_AC
                        Select the atmospheric correction GIPP
  --GIP_L2A_PB GIP_L2A_PB
                        Select the processing baseline GIPP
```

PDGS mode for GENERATE_DATASTRIP

Example for command line:

```
L2A_Process.py
  --mode=generate_datastrip
  --datastrip=<DATASTRIP_EXAMPLE_DIRECTORY>/
S2A_OPER_MSI_L1C_DS_SGS__20171129T040150_S20171129T023320_N02.06
  --work_dir=<WORK_EXAMPLE_DIRECTORY> /temp
  --output_dir=<OUTPUT_EXAMPLE_DIRECTORY>/output
  --processing_centre=EDRS
  --archiving_centre=SGS
  --GIP_L2A_PB=<GIP_EXAMPLE_DIRECTORY>/L2A_PB_GIPP.xml
```

PDGS mode for PROCESS_TILE

Example for command line:

```
L2A_Process.py
  --mode=process_tile
  --datastrip=<DATASTRIP_EXAMPLE_DIRECTORY>
/DS_SGS__20180130T143750_20171129T023320
  --tile=<TILE_EXAMPLE_DIRECTORY>
/S2A_OPER_MSI_L1C_TL_SGS__20171129T040150_A012727_T50PRA_N02.06
  --work_dir=<WORK_EXAMPLE_DIRECTORY>
  --output_dir=<OUTPUT_EXAMPLE_DIRECTORY>
  --GIP_L2A_PB=<GIP_EXAMPLE_DIRECTORY>/L2A_PB_GIPP.xml
  --img_database_dir=<DB_EXAMPLE_DIRECTORY_1>
  --res_database_dir=<DB_EXAMPLE_DIRECTORY_2>
  --raw
```

A new GIPP 'GIP_PROBA2' GIPP file of the format below can be provided as input to Sen2Cor as an additional optional command line argument (see paragraph 3.3.2 together with the list of other GIPPs) in order to define the processing baseline identifier of the generated L2A products. Sen2Cor is able to read this new input and use the corresponding value of the processing baseline filed in the relevant metadata and file/folder names of the L2A output product structure. In case the GIPP is not given as input, Sen2Cor uses the processing baseline identifier from the input Level-1C (in the L1C Datastrip metadata file).

```
<?xml version="1.0" encoding="UTF-8" standalone="no"?>
<GS2_PROCESSING_BASELINE_PARAMETERS
xmlns:xsi="http://www.w3.org/2001/XMLSchema-instance"
  xsi:noNamespaceSchemaLocation="L2A_PB_GIPP.xsd">
  <DATA>
    <Idp_Sc_List workflow="l2a">
      <Idp_Sc_Name>Sen2Cor</Idp_Sc_Name>
      <Idp_Sc_Version>02.07.00</Idp_Sc_Version>
    </Idp_Sc_List>
    <Baseline_Version>02.07</Baseline_Version>
  </DATA>
</GS2_PROCESSING_BASELINE_PARAMETERS>
```

3.3.2 Command line Options for TOOLBOX mode

Calling the script L2A_Process with the option '-h' via command line displays the following menu:

```

Command Line Parameters
("Toolbox" mode using L1C product as input_dir)

usage: L2A_Process.py [-h] [--mode MODE] [--resolution {10,20,60}]
                    [--datastrip DATASTRIP] [--tile TILE]
                    [--output_dir OUTPUT_DIR] [--work_dir WORK_DIR]
                    [--img_database_dir IMG_DATABASE_DIR]
                    [--res_database_dir RES_DATABASE_DIR]
                    [--processing_centre PROCESSING_CENTRE]
                    [--archiving_centre ARCHIVING_CENTRE]
                    [--processing_baseline PROCESSING_BASELINE] [--raw]
                    [--tif] [--sc_only] [--sc_classic] [--sc_cog]
                    [--cr_only] [--debug] [--GIP_L2A GIP_L2A]
                    [--GIP_L2A_SC GIP_L2A_SC] [--GIP_L2A_AC GIP_L2A_AC]
                    [--GIP_L2A_PB GIP_L2A_PB]
                    input_dir

Sen2Cor. Version: 2.10.01, created: 2021.12.13, supporting Level-1C product
version 14.2 - 14.9.

positional arguments:
  input_dir            Directory of Level-1C input

optional arguments:
  -h, --help          show this help message and exit
  --mode MODE         Mode: generate_datastrip, process_tile
  --resolution {10,20,60}
                    Target resolution, can be 10, 20 or 60m. If omitted,
                    only 20 and 10m resolutions will be processed
  --datastrip DATASTRIP
                    Datastrip folder
  --tile TILE         Tile folder
  --output_dir OUTPUT_DIR
                    Output directory
  --work_dir WORK_DIR
                    Work directory
  --img_database_dir IMG_DATABASE_DIR
                    Database directory for L1C input images
  --res_database_dir RES_DATABASE_DIR
                    Database directory for results and temporary products
  --processing_centre PROCESSING_CENTRE
                    Processing centre as regex: ^[A-Z_]{4}$, e.g. "SGS_"
  --archiving_centre ARCHIVING_CENTRE
                    Archiving centre as regex: ^[A-Z_]{4}$, e.g. "SGS_"
  --processing_baseline PROCESSING_BASELINE
                    Processing baseline in the format: "dd.dd", where
                    d=[0:9]
  --raw              Export raw images in rawl format with ENVI hdr
  --tif              Export raw images in TIFF format instead of JPEG-2000
  --sc_only          Performs only the scene classification at 60 or 20m
                    resolution
  --sc_classic       Performs scene classification in Sen2Cor 2.9 mode
  --sc_cog           Export SCL image in COG format instead of JPEG_2000
  --cr_only          Performs only the creation of the L2A product tree, no
                    processing
  --debug           Performs in debug mode
  --GIP_L2A GIP_L2A
                    Select the user GIPP
  --GIP_L2A_SC GIP_L2A_SC
                    Select the scene classification GIPP
  
```

Command Line Parameters
 ("Toolbox" mode using L1C product as input_dir)

```
--GIP_L2A_AC GIP_L2A_AC
    Select the atmospheric correction GIPP
--GIP_L2A_PB GIP_L2A_PB
    Select the processing baseline GIPP
```

Usage in Toolbox mode:

The <input_dir> argument is **mandatory** in Toolbox mode and can be either a relative or an absolute pathname. Input is expected to be a L1C product directory in compact SAFE format. Output will also be formatted as compact SAFE.

Note: Older versions (L1C products with Processing Baseline <= N0204) having the standard SAFE format are no longer supported.

If a relative pathname is given, it is expected that the user is calling Sen2Cor from inside a parent directory. Sen2cor will expand the absolute pathname for that directory.

The pathname shall point to a L1C user product.

Sen2cor will use the L1C user product identifier for generating a subsequent L2A product. For this purpose, the L1C source directory must start with an identifier like '**S2[A|B]*L1C***' which is the standard, if you download a L1C user product from the Sentinel 2 data hub. The generated product will get the identifier '**S2[A|B]*L2A***', and the current timestamp in UTC format. Everything else will be inherited from the L1C source.

The output directory for the L2A data selected by the command line, giving an absolute path for the target directory. By default, the processor will create the output product in the same directory where the L1C user product is created, but replacing "L1C" with "L2A" and updates the timestamp for the generation time.

--resolution is the target resolution for the product to be processed. See section 2.4.1 for details. If resolution is omitted, all resolutions will be generated (providing that the option **Downsample_20_to_60** be selected in the L2A_GIPP.xml).

On L1C User Product Level:

Absolute path:

```
L2A_Process
</the_L1C_product_directory>/<the_L1C_product_in_short_naming_convention> --
resolution=60
```

Relative Path (the command must be called from inside the user product directory):

```
L2A_Process <the_L1C_product_in_short_naming_convention> --resolution=60
```

3.3.3 Integration into the Sentinel-2 Toolbox

A detailed instruction the installation of Sen2Cor under the umbrella of the Sentinel-2 Toolbox can be found here:

<https://www.youtube.com/channel/UCPnL3aynCQxTOjPttxMiS3Q>

3.4 The Software Development Environment

This chapter describes all necessary steps to install, configure and operate the necessary tools in order to extend or maintain the processor software. Due to contractual reasons (See ATCOR License Agreement, below) parts of the Sen2Cor source code are restricted. The content of this chapter is thus primarily dedicated to developers and maintainers of the Sentinel 2 Level-2A Mission Performance Centre, which have access to the sources of the Atmospheric Correction module in the Project GIT repository.

The python runtime environment and the PyCharm IDE used for development purposes runs on all three operating systems, Windows, Linux and macOS.

3.4.1 Set up of the python runtime environment:

The set up will be performed using the conda package manager as follows:

1. Get the miniconda base installation for your operating system from: <https://docs.conda.io/en/latest/miniconda.html> and install it according to the installation instructions for your operating system.
2. Activate your command line interpreter.
3. Check the proper installation with `conda info`. It should show something like:

```
active environment : base
active env location : /Users/user/opt/miniconda2
shell level : 1
user config file : /Users/user/.condarc
populated config files :
conda version : 4.8.3
conda-build version : not installed
python version : 2.7.18.final.0
virtual packages : __osx=10.15.5
base environment : /Users/user/opt/miniconda2 (writable)
channel URLs : https://repo.anaconda.com/pkgs/main/osx-64
               https://repo.anaconda.com/pkgs/main/noarch
               https://repo.anaconda.com/pkgs/r/osx-64
               https://repo.anaconda.com/pkgs/r/noarch
package cache : /Users/user/opt/miniconda2/pkgs
                /Users/user/.conda/pkgs
envs directories : /Users/user/opt/miniconda2/envs
                  /Users/user/.conda/envs
platform : osx-64
user-agent : conda/4.8.3 requests/2.22.0 CPython/2.7.18 Darwin/19.5.0 OSX/10.15.5
UID:GID : 501:20
netrc file : None
offline mode : False
```

(!) Note that the prefix will be different on your system.

4. copy the yml configuration file called **sen2cor_2_10_0.yml** which is provided in the attachment of this document in section 3.4.4 and execute the following command:

```
conda env create --prefix /Users/user/opt/miniconda2/envs/sen2cor -f env_sen2cor_2_10_0.yml
```

5. Switch to the new environment with:

```
conda activate sen2cor
```

You can then check the new environment with:

```
which python
```

```
/Users/user/opt/miniconda2/envs/sen2cor/bin/python
```

The yml file contains a comprehensive list of all python packages installed, including their version numbers.

3.4.2 The PyCharm IDE

1. Install the PyCharm IDE for your operating system from: <https://www.jetbrains.com/pycharm/> and follow the installation instructions.
2. Start PyCharm and get the Sen2Cor sources from the S2-MPC GIT Repository.

3.4.3 Configuration

The Configuration has to be performed in two different steps:

1. Register the sen2cor Conda Environment in PyCharm via /Preferences/Project:SEN2COR/Project Interpreter ADD:

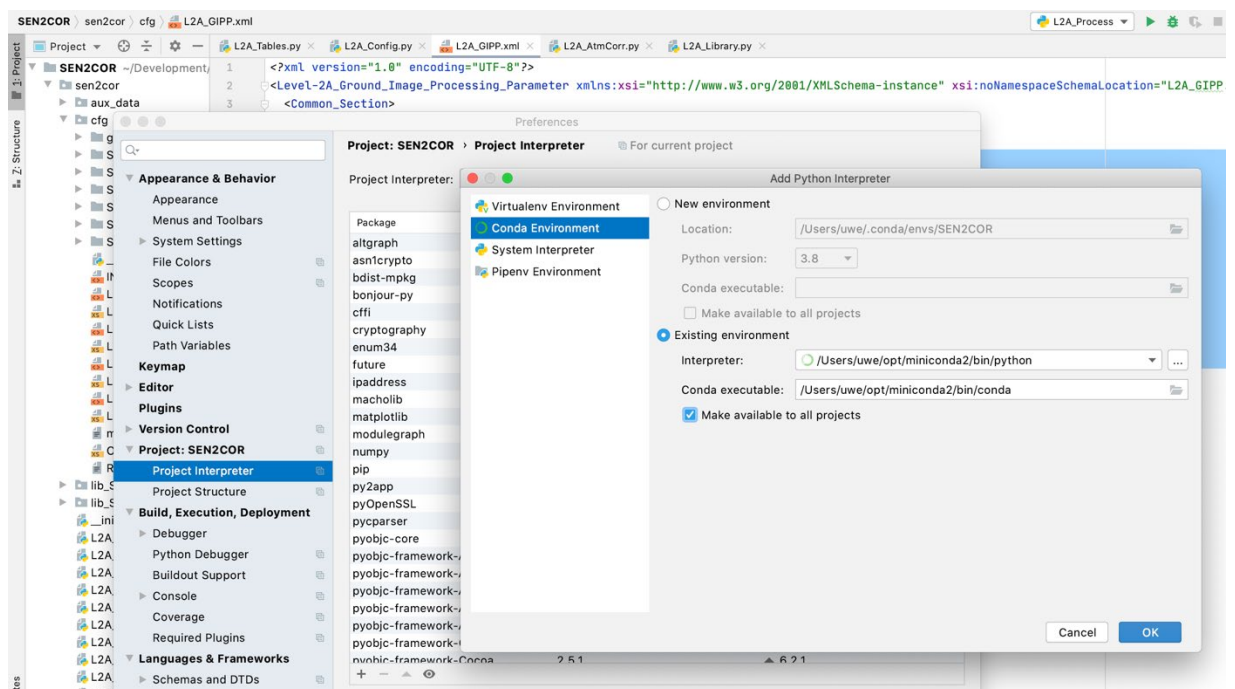

Figure 3-21 Registration of Sen2Cor Conda Environment in PyCharm

2. Connect the Sen2Cor sources with its runtime environment via /Run/Edit Configurations/

3.4.4 Conda environment yml

 Sen2Cor_2_10_0.yml

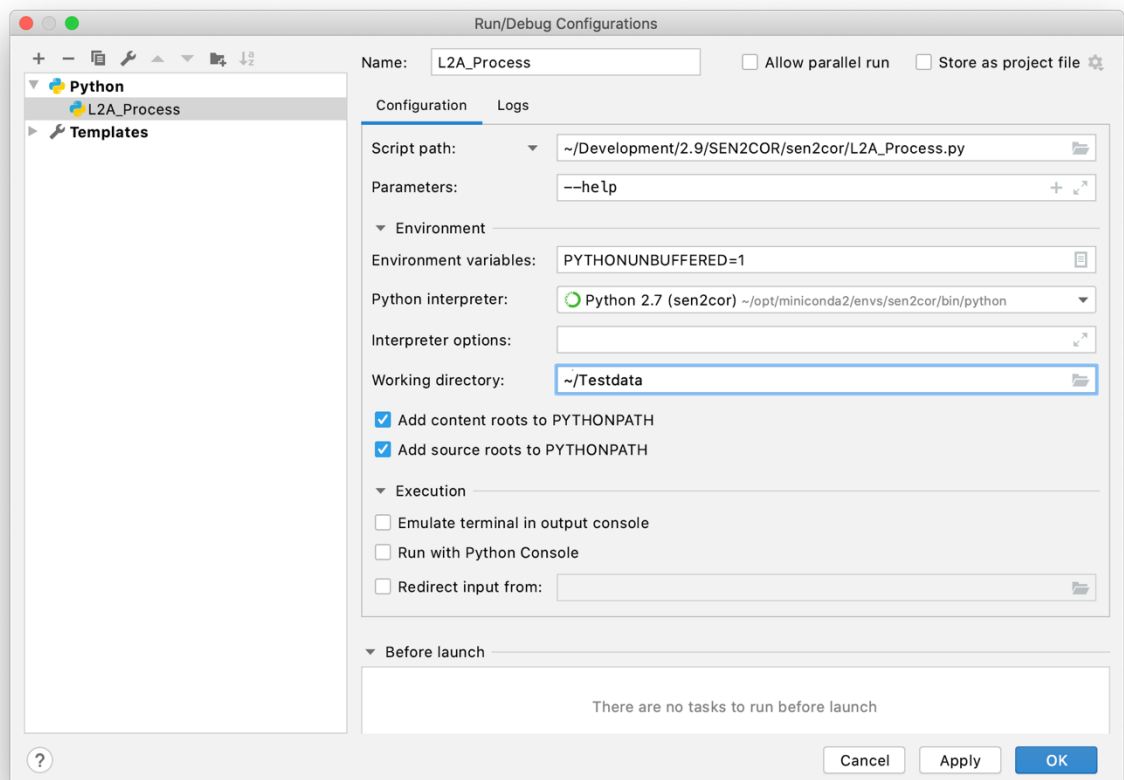

Figure 3-22 Connection of Sen2Cor Sources with Run Time Environment

3. You are now ready to run and debug the application.

4. References

1. Richter, R., Wang, X., Bachmann, M. and Schlaepfer, D. (2011). Correction of cirrus effects in Sentinel-2 type of imagery. *International Journal of Remote Sensing*, **32**, 2931-2941.
2. Louis, J., A. Charantonis, A. and Berthelot, B (2010). Cloud Detection for Sentinel-2. *Proceedings of ESA Living Planet Symposium*.
3. Salomonson V.V., I. Appel I. (2004). Estimating fractional snow cover from MODIS using the normalized difference snow index. *Remote Sensing of Environment* **89**, 351-360.
4. Vane, G., Green, R. O., Chrien, T. G., Enmark, H. T., Hansen, E. G., and Porter, W. M. (1993). The airborne visible / infrared imaging spectrometer (AVIRIS). *Remote Sens. Environ.* **44**, 127-143.
5. Kaufman, Y., et al. (1997). The MODIS 2.1 μm channel – correlation with visible reflectance for use in remote sensing of aerosol. *IEEE TGRS*, **35**, 1286 – 1298.
6. Schläpfer, D. et al. (1998). Atmospheric precorrected differential absorption technique to retrieve columnar water vapour. *Remote Sens. Environ.*, **65**, 353-366.

5. Copyright Notes

Apache License
Version 2.0, January 2004
<http://www.apache.org/licenses/>

TERMS AND CONDITIONS FOR USE, REPRODUCTION, AND DISTRIBUTION

1. Definitions.

"License" shall mean the terms and conditions for use, reproduction, and distribution as defined by Sections 1 through 9 of this document.

"Licensor" shall mean the copyright owner or entity authorized by the copyright owner that is granting the License.

"Legal Entity" shall mean the union of the acting entity and all other entities that control, are controlled by, or are under common control with that entity. For the purposes of this definition, "control" means (i) the power, direct or indirect, to cause the direction or management of such entity, whether by contract or otherwise, or (ii) ownership of fifty percent (50%) or more of the outstanding shares, or (iii) beneficial ownership of such entity.

"You" (or "Your") shall mean an individual or Legal Entity exercising permissions granted by this License.

"Source" form shall mean the preferred form for making modifications, including but not limited to software source code, documentation source, and configuration files.

"Object" form shall mean any form resulting from mechanical transformation or translation of a Source form, including but not limited to compiled object code, generated documentation, and conversions to other media types.

"Work" shall mean the work of authorship, whether in Source or Object form, made available under the License, as indicated by a copyright notice that is included in or attached to the work (an example is provided in the Appendix below).

"Derivative Works" shall mean any work, whether in Source or Object form, that is based on (or derived from) the Work and for which the editorial revisions, annotations, elaborations, or other modifications represent, as a whole, an original work of authorship. For the purposes of this License, Derivative Works shall not include works that remain separable from, or merely link (or bind by name) to the interfaces of, the Work and Derivative Works thereof.

"Contribution" shall mean any work of authorship, including the original version of the Work and any modifications or additions to that Work or Derivative Works thereof, that is intentionally submitted to Licensor for inclusion in the Work by the copyright owner or by an individual or Legal Entity authorized to submit on behalf of the copyright owner. For the purposes of this definition, "submitted" means any form of electronic, verbal, or written communication sent to the Licensor or its representatives, including but not limited to communication on electronic mailing lists, source code control systems, and issue tracking systems that are managed by, or on behalf of, the Licensor for the purpose of discussing and improving the Work, but excluding communication that is conspicuously marked or otherwise designated in writing by the copyright owner as "Not a Contribution."

"Contributor" shall mean Licensor and any individual or Legal Entity on behalf of whom a Contribution has been received by Licensor and subsequently incorporated within the Work.

2. Grant of Copyright License. Subject to the terms and conditions of this License, each Contributor hereby grants to You a perpetual, worldwide, non-exclusive, no-charge, royalty-free, irrevocable copyright license to reproduce, prepare Derivative Works of, publicly display, publicly perform, sublicense, and distribute the Work and such Derivative Works in Source or Object form.
3. Grant of Patent License. Subject to the terms and conditions of this License, each Contributor hereby grants to You a perpetual, worldwide, non-exclusive, no-charge, royalty-free, irrevocable (except as stated in this section) patent license to make, have made, use, offer to sell, sell, import, and otherwise transfer the Work, where such license applies only to those patent claims licensable by such Contributor that are necessarily infringed by their Contribution(s) alone or by combination of their Contribution(s) with the Work to which such Contribution(s) was submitted. If You

institute patent litigation against any entity (including a cross-claim or counterclaim in a lawsuit) alleging that the Work or a Contribution incorporated within the Work constitutes direct or contributory patent infringement, then any patent licenses granted to You under this License for that Work shall terminate as of the date such litigation is filed.

4. Redistribution. You may reproduce and distribute copies of the Work or Derivative Works thereof in any medium, with or without modifications, and in Source or Object form, provided that You meet the following conditions:
- (a) You must give any other recipients of the Work or Derivative Works a copy of this License; and
 - (b) You must cause any modified files to carry prominent notices stating that You changed the files; and
 - (c) You must retain, in the Source form of any Derivative Works that You distribute, all copyright, patent, trademark, and attribution notices from the Source form of the Work, excluding those notices that do not pertain to any part of the Derivative Works; and
 - (d) If the Work includes a "NOTICE" text file as part of its distribution, then any Derivative Works that You distribute must include a readable copy of the attribution notices contained within such NOTICE file, excluding those notices that do not pertain to any part of the Derivative Works, in at least one of the following places: within a NOTICE text file distributed as part of the Derivative Works; within the Source form or documentation, if provided along with the Derivative Works; or, within a display generated by the Derivative Works, if and wherever such third-party notices normally appear. The contents of the NOTICE file are for informational purposes only and do not modify the License. You may add Your own attribution notices within Derivative Works that You distribute, alongside or as an addendum to the NOTICE text from the Work, provided that such additional attribution notices cannot be construed as modifying the License.

You may add Your own copyright statement to Your modifications and

may provide additional or different license terms and conditions for use, reproduction, or distribution of Your modifications, or for any such Derivative Works as a whole, provided Your use, reproduction, and distribution of the Work otherwise complies with the conditions stated in this License.

5. Submission of Contributions. Unless You explicitly state otherwise, any Contribution intentionally submitted for inclusion in the Work by You to the Licensor shall be under the terms and conditions of this License, without any additional terms or conditions.
Notwithstanding the above, nothing herein shall supersede or modify the terms of any separate license agreement you may have executed with Licensor regarding such Contributions.
6. Trademarks. This License does not grant permission to use the trade names, trademarks, service marks, or product names of the Licensor, except as required for reasonable and customary use in describing the origin of the Work and reproducing the content of the NOTICE file.
7. Disclaimer of Warranty. Unless required by applicable law or agreed to in writing, Licensor provides the Work (and each Contributor provides its Contributions) on an "AS IS" BASIS, WITHOUT WARRANTIES OR CONDITIONS OF ANY KIND, either express or implied, including, without limitation, any warranties or conditions of TITLE, NON-INFRINGEMENT, MERCHANTABILITY, or FITNESS FOR A PARTICULAR PURPOSE. You are solely responsible for determining the appropriateness of using or redistributing the Work and assume any risks associated with Your exercise of permissions under this License.
8. Limitation of Liability. In no event and under no legal theory, whether in tort (including negligence), contract, or otherwise, unless required by applicable law (such as deliberate and grossly negligent acts) or agreed to in writing, shall any Contributor be liable to You for damages, including any direct, indirect, special, incidental, or consequential damages of any character arising as a result of this License or out of the use or inability to use the Work (including but not limited to damages for loss of goodwill, work stoppage, computer failure or malfunction, or any and all other commercial damages or losses), even if such Contributor has been advised of the possibility of such damages.
9. Accepting Warranty or Additional Liability. While redistributing

the Work or Derivative Works thereof, You may choose to offer, and charge a fee for, acceptance of support, warranty, indemnity, or other liability obligations and/or rights consistent with this License. However, in accepting such obligations, You may act only on Your own behalf and on Your sole responsibility, not on behalf of any other Contributor, and only if You agree to indemnify, defend, and hold each Contributor harmless for any liability incurred by, or claims asserted against, such Contributor by reason of your accepting any such warranty or additional liability.

END OF TERMS AND CONDITIONS

Copyright 2017, ESA

Licensed under the Apache License, Version 2.0 (the "License"); you may not use this file except in compliance with the License. You may obtain a copy of the License at

<http://www.apache.org/licenses/LICENSE-2.0>

Unless required by applicable law or agreed to in writing, software distributed under the License is distributed on an "AS IS" BASIS, WITHOUT WARRANTIES OR CONDITIONS OF ANY KIND, either express or implied.

See the License for the specific language governing permissions and limitations under the License.

ATCOR License Agreement

The program "ATCOR" (hereinafter called "program") is proprietary of the German Aerospace center (Deutsches Zentrum Für Luft- und Raumfahrt e.V., DLR) and is protected by the German Copyright Act. The program is made available to customer only for the purpose of use for the ESA Sentinel-2-project, the use of ATCOR for other projects is expressly excluded. With acceptance of these terms of a license the customer receives - without the right to grant sublicenses - a non exclusive, non transferable right to use the program for Sentinel-2 project. This right comprises the right to reprocess the source-code and to translate the source-code into a different programming language (hereinafter called "derived ATCOR")

Definition of the terms ATCOR sources and ATCOR binaries:

The term ATCOR sources specify the following three items: the source code of ATCOR or the source code or Python byte code of the derived ATCOR program.

The term ATCOR binaries specify a non-readable version of the derived ATCOR program. This can be either a binary executable program or an object library which is compiled from the derived ATCOR sources

The ATCOR sources may only be used for own purposes of the customer related to the Sentinel-2 project. The transfer of the ATCOR sources to third parties other than ESA and its ESA selected contractors, or the use of ATCOR sources for other projects than Sentinel-2 is subject to the prior written consent of DLR. No restrictions shall be given in the use of ATCOR binaries.

Notice of Third Party Software Licenses

This package contains open source software binaries and or python code from external projects. These are available on an "as is" basis and subject to their individual license agreements. This package is subject to their individual licenses as well as the Sen2Cor code license. Sen2cor development team reserves the right to change which third party tools will be provided in any version of this project. Changes to license in individual packages will be updated in this file.

Sen2cor windows package contains re-distributable, run-time, shared-library files from the Intel(TM) Math Kernel Library ("MKL binaries"). You are specifically authorized to use the MKL binaries. Use and redistribution of the MKL binaries are subject to the licensing terms located at <https://software.intel.com/en-us/license/intel-simplified-software-license>. However, GNU/Linux and Apple Mac OSX platforms are free from intel MKL binaries.

This software includes code from Python(R) project

Copyright (c) 2001, 2002, 2003, 2004, 2005, 2006 Python Software Foundation;

<http://www.python.org/>

Python(R) is a registered trademark of the Python Software Foundation.

Python is released under PSF License:

<https://docs.python.org/2/license.html>

This software includes code from open-cv2.

Copyright (c) 2016, opencv Developers

<https://pypi.org/project/opencv-python/>

Opencv is released under standart MIT Licence:

<https://github.com/opencv/opencv-python/blob/master/LICENSE.txt>

This software includes binaries from musl libc

Copyright © 2005-2014 Rich Felker, et al.

<http://www.musl-libc.org/>

Musl is released under standard MIT License:

<http://git.musl-libc.org/cgit/musl/tree/COPYRIGHT>

This software includes code from GDAL.

Copyright (c) 2000-2016, Frank Warmerdam

<http://www.gdal.org/>

GDAL is released under X11/MIT License:

<https://trac.osgeo.org/gdal/wiki/FAQGeneral#WhatlicensedoesGDALOGRuse>

This software includes code from numpy

Copyright (c) 2005, NumPy Developers

<http://www.numpy.org/>
Numpy is released under BSD-New license:
<https://docs.scipy.org/doc/numpy-1.10.0/license.html>

This software includes code from scipy
Copyright © 2001, 2002 Enthought, Inc.
Copyright © 2003-2013 SciPy Developers.
<http://www.scipy.org/>
Scipy is released under BSD-New license:
<https://www.scipy.org/scipylib/license.html>

This software includes code from pytables
Copyright (c) 2002-2004 by Francesc Altet
Copyright (c) 2005-2007 by Carabos Coop. V.
Copyright (c) 2008-2010 by Francesc Altet
Copyright (c) 2011-2015 by PyTables maintainers
<http://www.pytables.org/>
pytables is released under BSD 3-clause "New" or "Revised" License
<https://github.com/PyTables/PyTables/blob/2.2-pro/LICENSE.txt>

This software includes code from hdf5
Copyright (c) 2006, The HDF Group.
Copyright (c) 1998-2006, The Board of Trustees of the University of Illinois.
<http://www.hdfgroup.org/>
License for hdf5 is given here:
<https://support.hdfgroup.org/products/licenses.html>

This software includes code from numexpr.
Copyright (c) 2007,2008 David M. Cooke <david.m.cooke@gmail.com>
Copyright (c) 2009,2010 Francesc Altet <faltet@pytables.org>
Copyright (c) 2011- See AUTHORS.txt
<https://github.com/pydata/numexpr>
numexpr is released under MIT License:
<https://github.com/pydata/numexpr/blob/master/LICENSE.txt>

This software includes code from lxml.
Copyright (c) 2004 Infrae. All rights reserved.
<http://lxml.de/>
lxml is released under BSD License
<https://github.com/lxml/lxml/blob/master/doc/licenses/BSD.txt>

This software includes code from psutil.

Copyright (c) 2009, Jay Loden, Dave Daeschler, Giampaolo Rodola'
<https://github.com/giampaolo/psutil>
psutil is distributed under BSD license
<https://github.com/giampaolo/psutil/blob/master/LICENSE>

This software includes code from skimage.
Copyright (C) 2011, the scikit-image team
<http://scikit-image.org/>
skimage is released under BSD License
<http://scikit-image.org/docs/0.12.x/license.html>

This software includes code from glymur.
Copyright (C) 2013 John Evans
<https://github.com/quintusdias/glymur>
glymur is released under MIT License
<https://github.com/quintusdias/glymur/blob/master/LICENSE.txt>

This software includes code from dateutil.
Copyright (c) 2003-2011 - Gustavo Niemeyer <gustavo@niemeyer.net>
Copyright (c) 2012-2014 - Tomi Pieviläinen <tomi.pievilainen@iki.fi>
Copyright (c) 2014-2016 - Yaron de Leeuw <me@jarondl.net>
Copyright (c) 2015- - Paul Ganssle <paul@ganssle.io>
<https://github.com/dateutil/dateutil/>
dateutil is released under Simplified BSD

This software includes code from matplotlib.
Copyright (c) 2012-2013 Matplotlib Development Team
<https://matplotlib.org/>
matplotlib is released under PSF license
<https://matplotlib.org/users/license.html>

This software includes code from Python Imaging Library (PIL).
Copyright (c) 1997-2011 by Secret Labs AB
Copyright (c) 1995-2011 by Fredrik Lundh
Pillow is the friendly PIL fork. It is
Copyright (c) 2010-2017 by Alex Clark and contributors
Pillow is licensed under the open source PIL Software License:
<https://github.com/python-pillow/Pillow/blob/master/LICENSE>

This software includes code from setuptools
<https://pypi.python.org/pypi/setuptools>

This software includes code from packaging
<https://pypi.python.org/pypi/packaging>

Files:

lib/python2.7/site-packages/sen2cor/L2A_CogConverter.py
lib/python2.7/site-packages/sen2cor/L2A_Config.py
lib/python2.7/site-packages/sen2cor/L2A_KTL_Tracker.py
lib/python2.7/site-packages/sen2cor/L2A_Library.py
lib/python2.7/site-packages/sen2cor/L2A_Logger.py
lib/python2.7/site-packages/sen2cor/L2A_Manifest.py
lib/python2.7/site-packages/sen2cor/L2A_Process.py
lib/python2.7/site-packages/sen2cor/L2A_ProcessDataStrip.py
lib/python2.7/site-packages/sen2cor/L2A_ProcessTilePDGS.py
lib/python2.7/site-packages/sen2cor/L2A_ProcessTileToolbox.py
lib/python2.7/site-packages/sen2cor/L2A_Quality.py
lib/python2.7/site-packages/sen2cor/L2A_SceneClass.py
lib/python2.7/site-packages/sen2cor/L2A_SceneClass_evolution.py
lib/python2.7/site-packages/sen2cor/L2A_Schedule.py
lib/python2.7/site-packages/sen2cor/L2A_Tables.py
lib/python2.7/site-packages/sen2cor/L2A_XmlParser.py
lib/python2.7/site-packages/sen2cor/__init__.py

Copyright: Copyright (C) 2017 European Space Agency (ESA).
All Rights reserved

License: Apache 2.0

Files : lib/python2.7/site-packages/sen2cor/aux_data/

Copyright : Copyright (C) 2017 European Space Agency (ESA).
All Rights reserved

License : Apache 2.0

Files : lib/python2.7/site-packages/sen2cor/cfg/*

Copyright : Copyright (C) 2017 European Space Agency (ESA).
All Rights reserved

License : Apache 2.0

Files : lib/python2.7/site-packages/sen2cor/lib_S2A/*

Copyright : Copyright (C) 2017 European Space Agency (ESA).
All Rights reserved

License : Apache 2.0

Files : lib/python2.7/site-packages/sen2cor/lib_S2B/*

Copyright : Copyright (C) 2017 European Space Agency (ESA).
All Rights reserved
License : Apache 2.0

See copyright/Sen2cor for full text of apache 2.0 license

Files: lib/python2.7/site-packages/sen2cor/L2A_AtCorr.so

Copyright: German Aerospace center (Deutsches Zentrum Für Luft- und Raumfahrt e.V., DLR)

License: see copyright/ATCOR which is the license granted to ESA by DLR

This software contains binaries from lapack project.

Copyright (c) 1992-2013 The University of Tennessee and The University of Tennessee Research Foundation. All rights reserved.

Copyright (c) 2000-2013 The University of California Berkeley. All rights reserved.

Copyright (c) 2006-2013 The University of Colorado Denver. All rights reserved.

<http://www.netlib.org/>

Lapack is released under modified BSD license:

<http://www.netlib.org/lapack/LICENSE.txt>

This package contains binaries from libpng project

<http://www.libpng.org/>

libpng is distributed under libpng license

Copyright and license are listed here:

<http://www.libpng.org/pub/png/src/libpng-LICENSE.txt>

This package contains binaries from zlib project

Copyright (C) 1995-2017 Jean-loup Gailly and Mark Adler

<https://www.zlib.net/>

zlib is released under zlib license:

https://www.zlib.net/zlib_license.html

This package contains binaries from curl project

<https://curl.haxx.se>

Curl is released under MIT/X derivative license:

<https://curl.haxx.se/docs/copyright.html>

This package contains binaries from jpeg-turbo project

<http://www.libjpeg-turbo.org>

libjpeg-turbo is covered by three compatible BSD-style open source licenses:

<https://github.com/libjpeg-turbo/libjpeg-turbo/blob/master/LICENSE.md>

This package contains binaries from libxslt
<http://xmlsoft.org>
xslt is released under MIT license:
<http://xmlsoft.org/XSLT/intro.html>

This package contains binaries from libexslt
<http://xmlsoft.org>
exslt is released under MIT license:
<http://xmlsoft.org/XSLT/EXSLT/index.html>

This package contains binaries from libxml2
<http://xmlsoft.org>
libxml2 is released under MIT license

This package contains binaries from libtiff
Copyright (c) 1988-1997 Sam Leffler
Copyright (c) 1991-1997 Silicon Graphics, Inc.
<http://www.libtiff.org/>
libtiff is released under BSD-like licence.

This package contains binaries from proj4
Copyright (c) 2000, Frank Warmerdam
proj4 is released under MIT licence:
<http://proj4.org/license.html>

This package contains binaries from libexpat
Copyright (c) 1998-2000 Thai Open Source Software Center Ltd and Clark Cooper
Copyright (c) 2001-2017 Expat maintainers
<https://libexpat.github.io/>
libexpat is released under MIT licence.
<https://github.com/libexpat/libexpat/blob/master/expat/COPYING>

This package contains binaries from Freetype2
Copyright (c) 2000, Frank Warmerdam
Freetype2 is released under FTL licence:
<http://git.savannah.gnu.org/cgi/freetype/freetype2.git/tree/docs/FTL.TXT>

This package contains binaries from libgeotiff project
libgeotiff is released under public domain or X style licence:
<https://svn.osgeo.org/metacrs/geotiff/trunk/libgeotiff/LICENSE>

This package contains binaries from SQLite project

<https://sqlite.org/>
SQLite is released under public domain
<https://sqlite.org/copyright.html>

This package contains binaries from OpenJPEG project
<http://www.openjpeg.org/>
OpenJPEG is released under 2-clause BSD license
<https://github.com/uclouvain/openjpeg/blob/master/LICENSE>

This package contains binaries from GNU Readline project
<https://cnswww.cns.cwru.edu/php/chet/readline/rltop.html>
Readline is released under GNU GPL v3 License.
<http://www.gnu.org/licenses/gpl.html>

This package contains binaries from lcms2 project
<http://www.littlecms.com/>
lcms2 is released under MIT license

This package contains binaries from libffi project
<https://sourceware.org/libffi/>
libffi is released under MIT license
<https://github.com/libffi/libffi/blob/master/LICENSE>

This package contains binaries from ncurses project
Copyright (c) 2011-2014, 2015 by Thomas E. Dickey
<https://www.gnu.org/software/ncurses/>
ncurses is distributed under MIT license
<http://invisible-island.net/ncurses/ncurses-license.html>

This package contains binaries from libssh2 project
<http://www.libssh2.org/>
ncurses is distributed under BSD license
<https://libssh2.org/license.html>

This package contains binaries from libressl project
<http://www.libressl.org/>
libressl is distributed under a mix of licenses
<https://github.com/libressl/libressl/blob/master/src/LICENSE>

This package contains binaries from gnupg project
<https://www.gnupg.org/>
gnupg is distributed under a GPL license

This package contains binaries from libbz2 project
Copyright (c) Julian Seward, jseward@bzip.org
<http://www.bzip.org/>
libbz2 is distributed under BSD license

This package contains binaries from BLAS project
<http://www.netlib.org/blas/>
BLAS is distributed under public domain

This package contains binaries from OpenBLAS project
<http://www.openblas.net/>
OpenBLAS is distributed under BSD License

This package contains binaries from GDBM project
<http://www.gnu.org.ua/software/gdbm/>
GDBM is released under GPL v3 License

This software includes binaries from GCC project
Copyright (C) 2009 Free Software Foundation, Inc.
libstdc++ has GCC Runtime Library Exception:
<https://gcc.gnu.org/onlinedocs/libstdc++/manual/license.html>
The libgcc library is licensed under the GNU GPL plus the GCC Runtime Library Exception